

CE Educator's Toolkit

Evidence-based design and implementation strategies
for effective continuing education

Support

The CE Educator's Toolkit was developed by the Society for Academic Continuing Medical Education (SACME) through an Accreditation Council for Continuing Medical Education (ACCME) research grant in fulfillment of ACCME's strategic goal to advocate for research and scholarship in continuing education.

Suggested Citation

Accreditation Council for Continuing Medical Education. 2022. CE Educator's Toolkit: Evidence-based design and implementation strategies for effective continuing education. <http://www.accme.org/ceeducatorstoolkit>

This toolkit may be used, distributed or presented for non-promotional educational purposes with attribution. Contact ACCME with questions on reproduction or use at info@accme.org.

About ACCME

ACCME's mission is to assure and advance quality learning for healthcare professionals that drives improvements in patient care.

ACCME.ORG

About SACME

SACME is committed to promoting the highest value in patient care and health of the public through the scholarship of continuing medical and interprofessional education.

SACME.ORG

Acknowledgements

Authors

The Society for Academic Continuing Medical Education

Betsy Williams, PhD, MPH
bwilliams@prckansas.org

David Wiljer, PhD
David.wiljer@uhn.ca

Joyce Fried, FSACME
joycemfried@gmail.com

Gabrielle Kane, MB, EdD, FRCPC
kaneg@uw.edu

The authors wish to thank the following individuals for their valuable contributions to this project.

Project Team:

Sharon Ambata-Villanueva, MA, CTDP
Ashleigh Jaggars, MPH
Tharshini Jeyakumar, MHI
Inaara Karsan, MHI
Morag Paton, PhD, MEd
Nathaniel Williams
Sarah Younus, MPH

Advisory Committee

Members:

Mik Bauer
Craig Campbell, MD, FRCPC
Asha Maharaj, MBA
Tymothi Peters
William Rayburn, MD, MBA
Suzan Schneeweiss, MD, MEd, FRCPC
Bitia Zakeri, PhD

Reviewers:

Rich Frankel, MBA
Gurpreet Grewal, B. Ed (ADED)
Ginny Jacobs, PhD, MEd, MLS, CHCP
Rebecca Kolb, MA
Patricia O'Sullivan, EdD
Ivan Silver, MD, MEd, FRCPC
Jane Tipping, MAEd, PCC (ICF)

ACCME:

Graham McMahon, MD, MMSc

Table of contents

Section One: Introduction to the toolkit	10	Conducting needs assessment	28
1.1 Introduction to CE	12	2.2 Develop targeted learning objectives	31
Why a CE Educator's Toolkit is needed	13	How to write a learning objective	32
How the toolkit was developed	14	How to make a learning objective actionable	36
Who should use this toolkit	16	2.3 IDEA principles	38
How to use the toolkit	17	Designing for inclusivity	39
Education intervention integration into CE session	18	Designing for diversity	40
Intention for practice change	20	Designing for equity	41
Self-assessment for CE planning preparedness	21	Designing for accessibility	42
Section Two: How to begin planning your CE	23	IDEA considerations when designing your CE intervention	43
2.1 Structure a longitudinal and multimodal education intervention	24	2.4 Key considerations for virtual CE delivery	45
PDSA cycle	25	2.5 Additional resources	46

Table of contents

Section Three: Educational interventions for CE sessions	48
3.1 Intervention one: Facilitation of small group learning	49
3.1.1 Introduction to facilitating small group learning	51
Why facilitate small group learning	52
Case scenario	53
Guiding questions for facilitating small group learning	54
Key enablers for facilitating small group learning	55
Formula for success	59
3.1.2 Framing the problem and preparation	60
Planning your small group discussion	61
Mind map: A teaching resource	62
Creating an inclusive, safe, and supportive space	65

Strategies for creating an inclusive, safe, and supportive space	66
Example of ground rules	67
Framing the problem and preparation checklist	68
3.1.3 Implementation guidelines	69
How to facilitate small group learning	70
Briefing checklist for small group learning	71
Importance of maintaining group dynamics	72
Tuckman's stages of small group development	73
Role of facilitator during small group learning	74
Facilitator techniques to encourage small group discussions	75
Importance of questioning for small group discussions	76
Questioning technique for facilitators	77

Table of contents

Debrief checklist for small group learning	78
Implementation checklist	79
3.1.4 Key considerations	80
Tips for effective delivery of small group learning	81
Challenges of facilitating small group learning	82
Mitigating challenges in small group learning	83
Planning canvas for small group learning	84
Evaluation consideration for small group learning	85
Additional resources	86
3.2 Intervention two: Case-based learning	87
3.2.1 Introduction to case-based learning	89
Why facilitate case-based learning	90

Case scenario	91
Guiding questions for case-based learning	92
Key enablers for case-based learning	93
Importance of case-based learning	97
Formula for success	98
3.2.2 Framing the problem and preparation	99
Types of cases	100
How to develop a case	101
Steps to writing a case study	103
Methods for presenting a case	104
Framing the problem and preparation checklist	105
3.2.3 Implementation guidelines	106

Table of contents

How to facilitate case-based learning	107
When to present the case	108
Examine case through social learning	109
Barriers to learning engagement	110
Facilitator's role in case-based learning discussion	111
Working through the cases	112
Questioning in case-based learning	114
Dissemination of case analysis	115
How to debrief the case	116
Implementation checklist	117
3.2.4 Key considerations	118
Group learning delivery methods	119

Challenges: Delivery approaches	120
Planning canvas for case-based learning	121
Evaluation consideration for case-based learning	122
Additional resources	123
3.3 Intervention three: Reflective learning	124
3.3.1 Introduction to reflective learning	126
Why facilitate reflective learning	127
Case scenario	128
Guiding questions for reflective learning	129
Key enablers for reflective learning	130
Formula for success	134
3.3.2 Framing the problem and preparation	135

Table of contents

Determine learning goals for reflective learning	136
When to use reflective learning	137
Importance of facilitator's role in reflective learning	138
What is brave space	139
Framing the problem and preparation checklist	141
3.3.3 Implementation guidelines	142
Stages of critical reflective inquiry model (CRI)	143
Applications of the critical reflective inquiry model	144
Implementation checklist	145
3.3.4 Key considerations	146
Key principles for facilitation of reflective learning	147
Considerations for facilitating reflective learning	148

Challenges with reflective learning	149
Using reflective practice within a virtual learning context	150
Evaluation consideration for reflective learning	153
Additional resources	154
Section Four: Assessing and evaluating CE interventions	155
4.1 Assessing knowledge comprehension of learners	158
4.2 Providing feedback on the session	159
4.3 How to evaluate the intervention	160
Identify key stakeholders	161
Create a logic model	162
Select an outcome framework for evaluation	165
RE-AIM framework	166

Table of contents

Kirkpatrick-Barr framework	168
Moore's framework	169
Evaluate if learners achieve outcomes	170
Evaluation approaches	171
Evaluation checklist	176
Additional resources	177
Reassess CE planning preparedness	178
Glossary of terms	180
References	184

Introduction to the toolkit

SECTION ONE

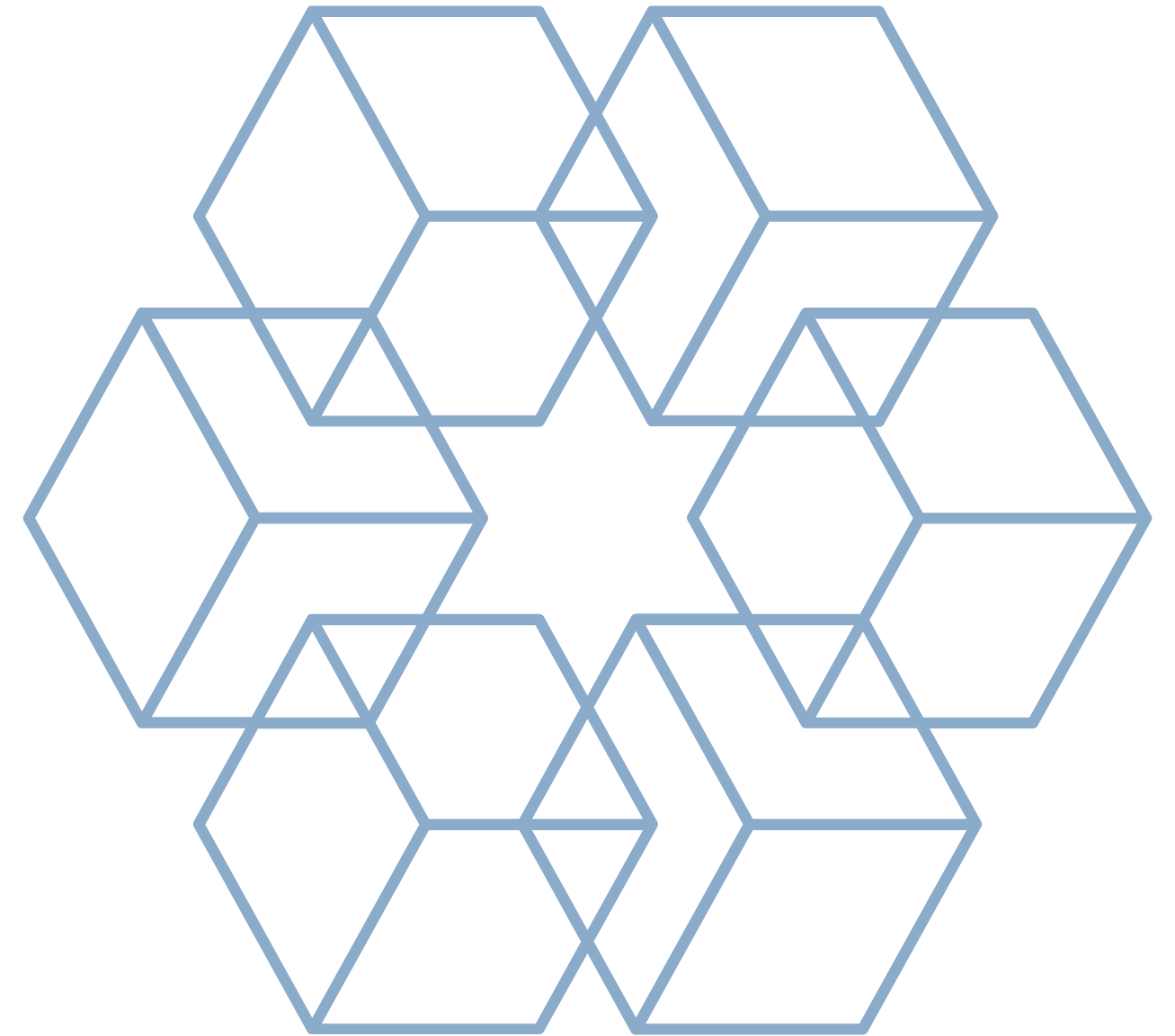

Section 1

In this section:

1.1 Introduction

- Introduction to CE
- Why a CE toolkit is needed
- How the toolkit was developed
- Who should use this toolkit

1.2 How to use the toolkit

- Choosing and integrating education interventions into your CE session
- Tips for education intervention integration

1.1 Introduction



Healthcare is complex and rapidly evolving; with this in mind, interdisciplinary care and professional development continues to be of great importance. There is a critical need for healthcare professionals to maintain and continuously update their knowledge and skills, and to reflect on changes that impact their practice. Accredited continuing education (CE) promotes a lifelong learning mindset of continuous professional development to gain new knowledge and skills.

Key Terms:

Continuing education (CE): CME, CPD, accredited CE are educational activities that serve to maintain, develop, or increase the knowledge, skills, and professional performance and relationships health professionals use to provide services for patients, the public, or the profession [1].

Continuing professional development (CPD): includes all activities that any health professional undertakes, formally and informally, including CE, in order to maintain, update, develop, and enhance their knowledge, skills, and attitudes in response to the needs of their patients [1].

Why a CE Educator's Toolkit *is needed*

CE interventions for healthcare professionals are more effective when instructional methods promote *critical thinking*, *collaboration*, and *decision-making* skills [2]. These methods improve team performance and encourage behavior change among healthcare professionals. In the absence of these methods, CE can be ineffective and feel unrewarding to learners. Therefore, educators should seek to evolve their educational programs to integrate principles of active learning and activities that promote engagement to make it more appealing for today's healthcare professional learners.

This toolkit aims to provide CE leaders, educators, and healthcare professionals with best practices and guidelines to assist in the design and delivery of CE in a manner that fosters a practical and active learning approach.

Although there are different approaches to CE interventions, this toolkit will focus on three key interventions based on evidence-driven investigation and consultation with medical education experts: (1) facilitation of small group learning, (2) case-based learning, and (3) reflective learning.

How the toolkit was developed

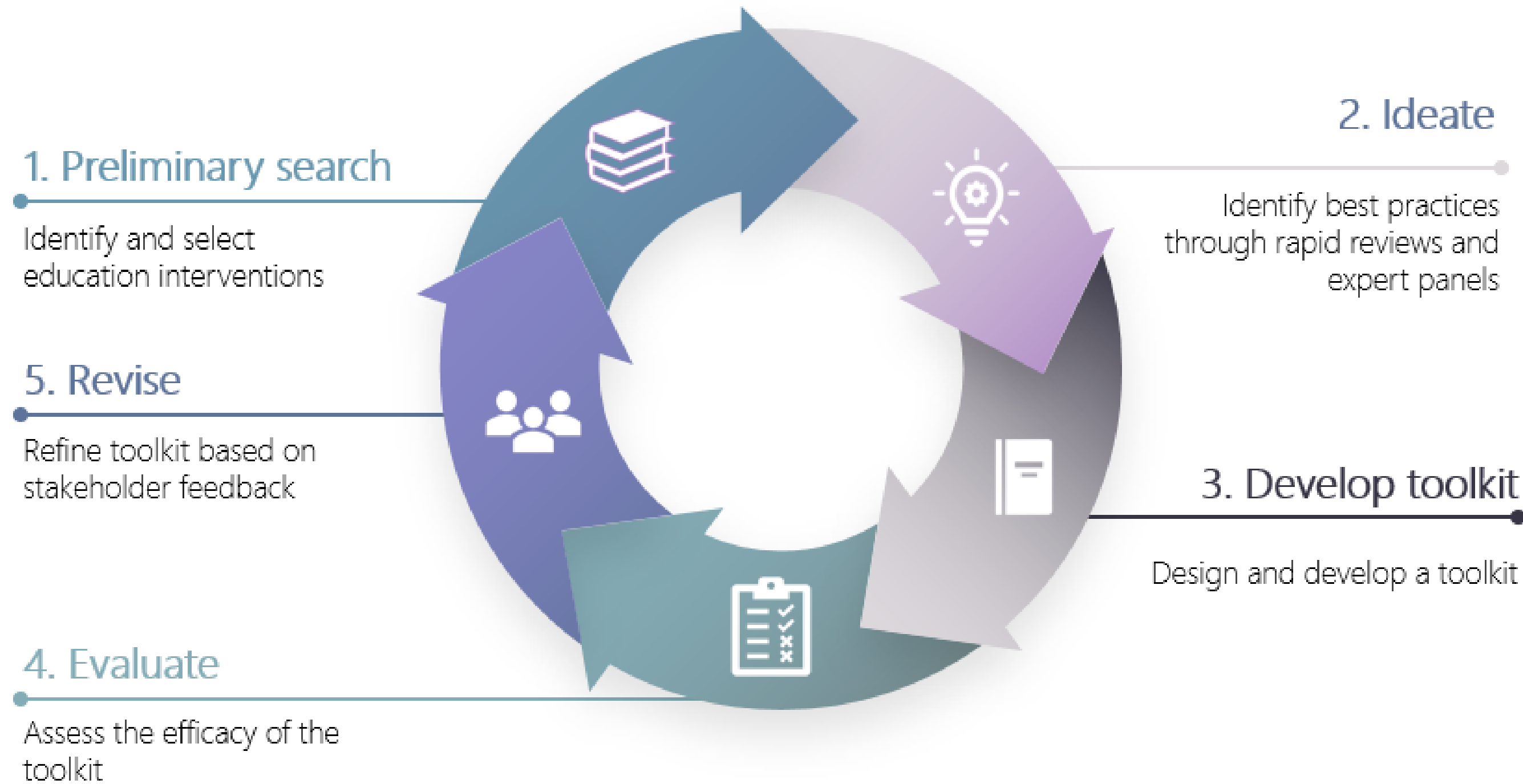

How the toolkit was developed

- 1 Preliminary search for educational strategies:** Effective education strategies for continuing professional development were identified following a review of the academic literature and discussions with experts in continuing education.
- 2 Identification of best practices:** Best practices in instructional design were identified through a rapid review of the literature and an eDelphi approach for each education intervention [3]. The rapid reviews of academic literature provided the foundation for developing evidence-based best practice recommendations for the design, implementation, and evaluation of the educational interventions. The findings from the rapid review were validated by an eDelphi panel consisting of academic professionals, CE experts, and healthcare professionals. The eDelphi approach involved a virtual focus group and survey to further identify best practice recommendations and practical implementation strategies for each education intervention.
- 3 Development of a toolkit:** An evidence-based toolkit was developed based on the recommendations drawn from the literature and continuing education professionals. The toolkit design focused on incorporating recommendations for each education intervention that will help CE leaders, educators, and healthcare professionals plan, implement, and evaluate their intervention to promote learner engagement, knowledge uptake, and practice change.
- 4 Review, validate, and revise:** The toolkit was reviewed for clarity, utility, and relevance to the target audience by a diverse group of stakeholders with varied experiences in CE. An iterative process was used to incorporate feedback from stakeholders throughout the toolkit design process.

Who should use **this toolkit**

The toolkit was created for the novice and intermediate experience level of CE development. However, this toolkit provides additional resources, planning templates, and helpful tips for those with advanced expertise in developing CE activities.

- 1 Healthcare leaders and educators
- 2 Accredited CE providers and their educational partners
- 3 Healthcare professionals

1.2 How to use the toolkit

The toolkit includes best practices and implementation guidelines to successfully plan and initiate education interventions for a broad range of healthcare professionals and CE leaders.

Integrated approach

This toolkit presents three education interventions. The interventions can be delivered independently or can be integrated and delivered as part of a larger activity such as a conference or longitudinal program.

Guiding questions

As you progress through the toolkit, use the guiding questions to reflect on how you will design your CE intervention.

Mini case scenarios

The mini case scenarios presented in each education intervention module include a hypothetical example of how the intervention can be applied.

Evaluation

The toolkit presents evaluation tools to assess learners' progress, address feedback and evaluate the effectiveness of your CE intervention.

Choose and integrate education interventions into your CE session

The selected strategies presented in this toolkit can be used in combination when designing a CE session. However, your CE session design is not limited to these education interventions. You can use them together or other learning approaches to deliver educational content.

The following diagram outlines unique features of each intervention discussed in this toolkit that can be incorporated within your CE session:

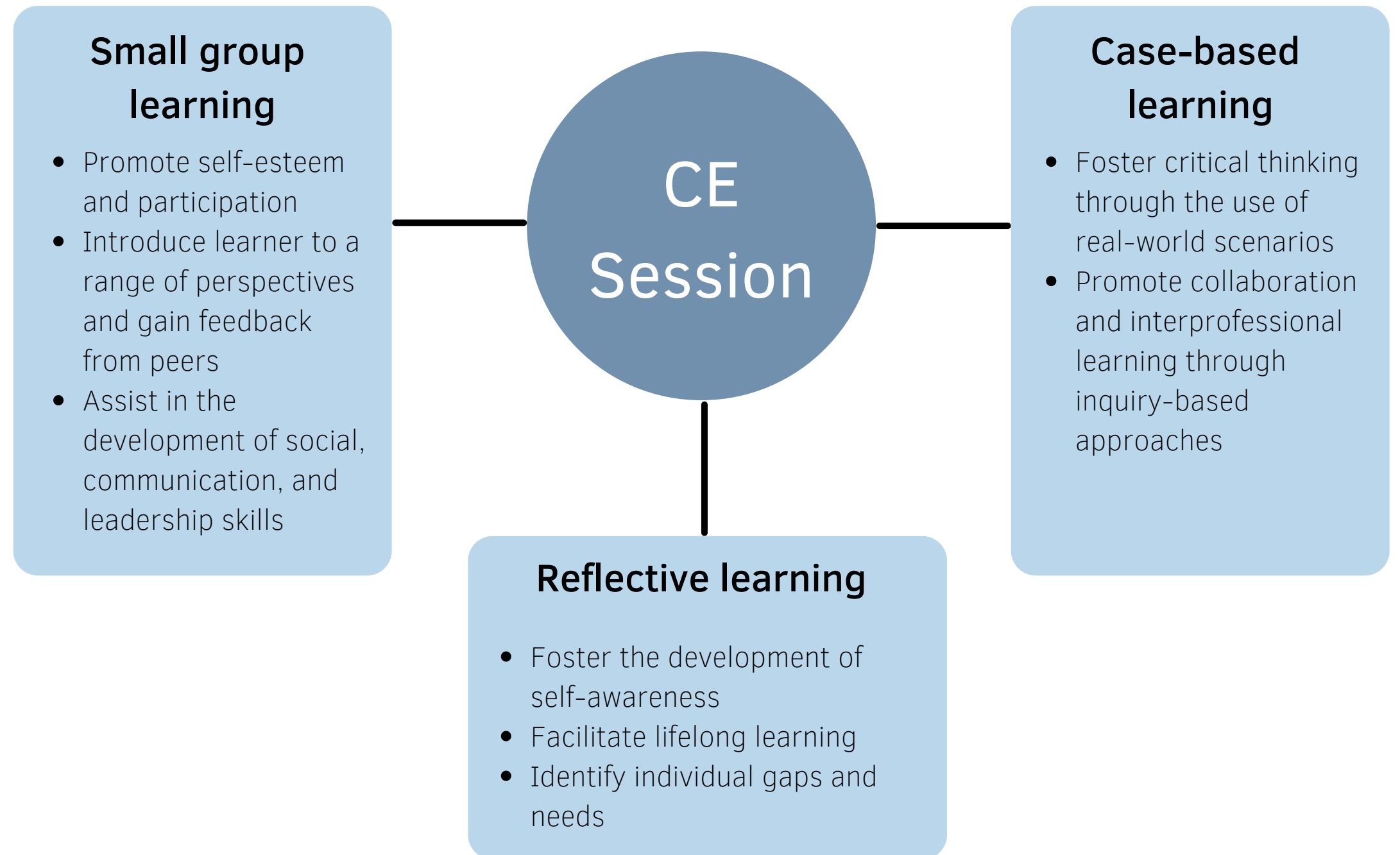

Tips for education intervention **integration**

As you go through the toolkit, consider how these education interventions can be integrated and combined into your CE intervention. Look out for sticky notes that will provide tips on how these interventions overlap.

A teal-colored sticky note with a folded bottom-right corner, containing the text "Facilitation of small group learning".

Facilitation of
small group
learning

A purple-colored sticky note with a folded bottom-right corner, containing the text "Case-based learning".

Case-based
learning

A maroon-colored sticky note with a folded bottom-right corner, containing the text "Reflective learning".

Reflective
learning

Intention for practice change

Self-efficacy plays a vital role between **knowledge acquisition** and the intention for **practice change** [4,5]. Self-efficacy often times is perceived to manifest as a barrier to change [4,6]. Many social cognitive theories suggest that one's actions are influenced by three key factors, personal, behavioral, and environmental [4].

As you go through the toolkit, strategies and best practices enclosed will demonstrate how these factors can be addressed to promote the successful delivery of a CE session. Consider the following barriers as you go through the toolkit and begin planning your CE session.

Barriers to change [4,7]

- Commitment to change
- Challenges with implementation
- Translating evidence into practice
- Availability of healthcare provider may hinder the implementation of new processes
- Lack of time to learn or practice a new concept
- Lack of peer or staff support
- Learning and teaching style
- Learners may not view them as effective change agents

Mitigation Strategies [8]

- Implementation support specialist to help with translating the knowledge.
- Tailored CE course
- Mentorship and coaching

Self-assessment for CE planning preparedness



If you are planning a CE session, use the following self-assessment tool to identify areas in the toolkit that will be beneficial to you. Focus your time on sections in the toolkit where you report low confidence to refine your skillset in CE planning and design. If you report confidence from levels 1 to 3, you may want to go through the content thoroughly and complete the activities. If you report a confidence level from 4 to 5, use the toolkit as a reference resource and use the worksheets to help with the design of your CE session.

Please rate your **level of confidence** with each of the CE planning components, learning formats, and evaluation activities on a scale of 1 (not at all familiar) to 5 (extremely familiar).

CE Component	Confidence level: 1 (Not at all) - 5 (Extremely)				
Initiating planning of CE session	1	2	3	4	5
Structuring a longitudinal and multimodal education intervention	1	2	3	4	5
Conducting a needs assessment	1	2	3	4	5
Developing learning objectives	1	2	3	4	5
Integrating principles of inclusion, diversity, equity, and accessibility into activities	1	2	3	4	5
Delivering CE sessions virtually	1	2	3	4	5
Facilitating small group learning	1	2	3	4	5
Planning and encouraging small group discussion	1	2	3	4	5
Creating an inclusive, safe, and supportive learning space	1	2	3	4	5
Maintaining group dynamics	1	2	3	4	5
Mitigating challenges and conflicts in groups	1	2	3	4	5

985_20230124

Self-assessment for CE planning preparedness



Please continue to rate your **level of confidence** with each of the CE planning components, learning formats, and evaluation activities on a scale of 1 (not at all familiar) to 5 (extremely familiar).

CE Component	Confidence level: 1 (Not at all) - 5 (Extremely)				
Case-based learning	1	2	3	4	5
Developing a case for activities	1	2	3	4	5
Presenting the use diverse methods and modalities	1	2	3	4	5
Identifying strategies for examining and engaging learners in case analysis	1	2	3	4	5
Defining the facilitator's role in case-based learning discussion	1	2	3	4	5
Conducting activities to disseminate case analysis and debrief the case	1	2	3	4	5
Reflective Learning	1	2	3	4	5
Determining learning goals and when to integrate reflective learning	1	2	3	4	5
Defining facilitator's role in reflective learning	1	2	3	4	5
Applying and integrating the critical reflective inquiry model in activities	1	2	3	4	5
Assessing and Evaluating CE Interventions	1	2	3	4	5
Assessing knowledge comprehension of learners	1	2	3	4	5
Providing and integrating feedback	1	2	3	4	5
Evaluating outcomes of intervention using structured frameworks	1	2	3	4	5
Selecting evaluation approaches to assess performance change or skill development	1	2	3	4	5

How to begin planning your CE session

SECTION TWO

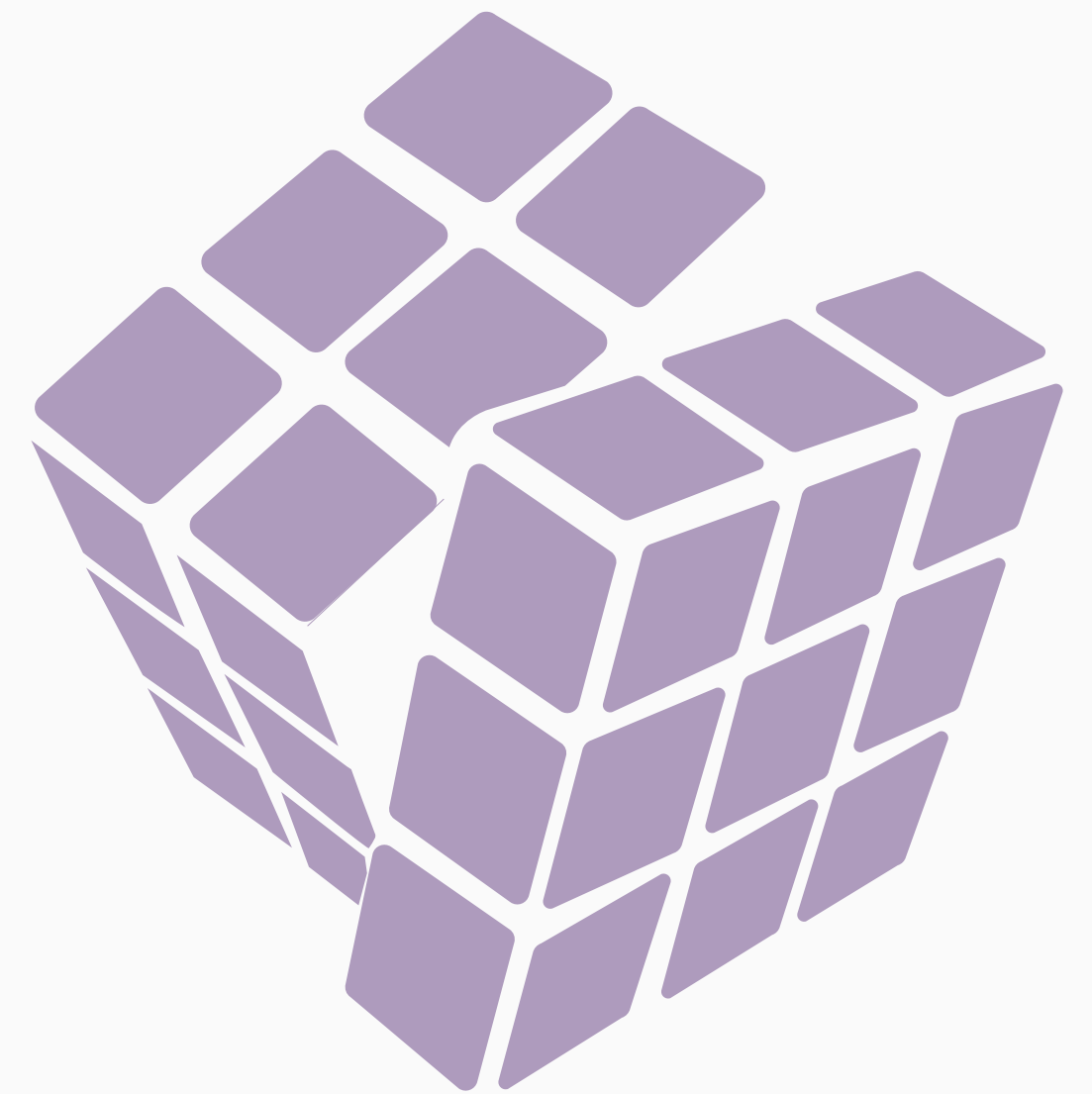

Section 2

In this section:

First steps to education intervention design

- Structure a longitudinal and multimodal education intervention
- Use the PDSA cycle to structure your CE intervention
- Conduct a needs assessment to understand the audience and their learning needs

Learning objectives

- Develop targeted learning objectives
- How to write a learning objective
- How to make a learning objective actionable

IDEA principles

- Designing for inclusivity
- Designing for diversity
- Designing for equity
- Designing for accessibility
- Checklist

Virtual delivery

- Key considerations for virtual delivery

2.1 Structure a longitudinal and multimodal education intervention

Use a **quality improvement** approach to structure a **longitudinal** education intervention that will allow learners to apply their knowledge, receive appropriate feedback, and have opportunities to enhance their learning.

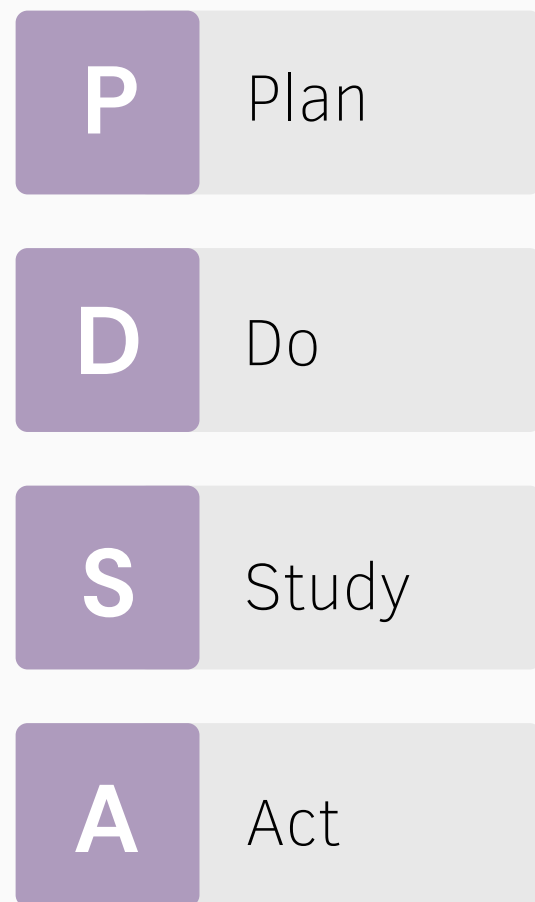

QUALITY IMPROVEMENT

- To increase the likelihood that learning will change practice, the CE planner should ideally create learning experiences that facilitate rehearsal, practice, and feedback using what was learned through a longitudinal and multimodal approach [9].
- Follow an iterative PDSA cycle to design and develop educational interventions that foster meaningful learning experiences and allow healthcare professionals to stay abreast of advances in clinical knowledge and skills while also developing a continuous learning mindset [9].

Use the PDSA cycle to structure your CE intervention

Following an iterative PDSA cycle to frame education interventions will provide added value to learners and enhance practice improvement and performance [10,11].

Use the PDSA cycle to structure and continually seek ways to improve your CE interventions.

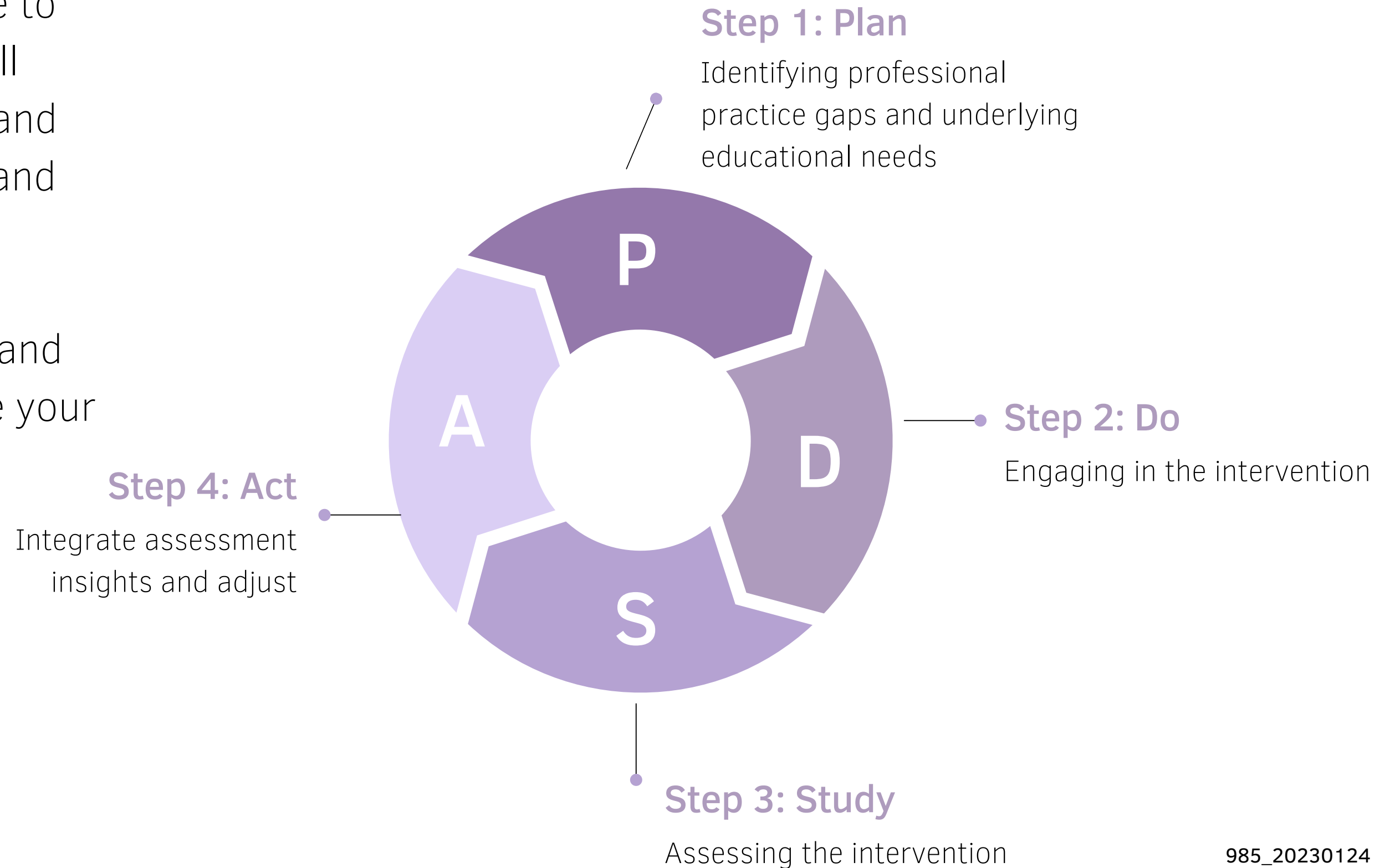

PDSA cycle

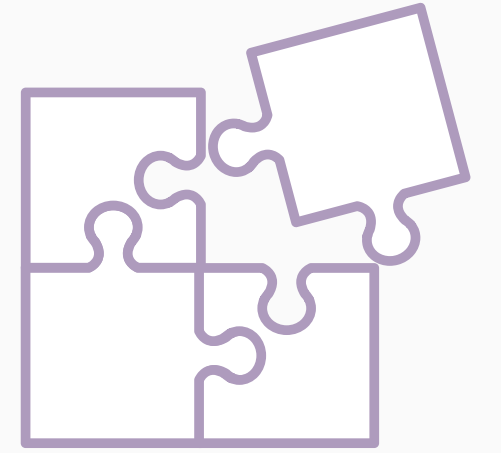

● Step 1: Plan

Identify current professional practice gaps and underlying educational needs. Design an education intervention that addresses learner needs to close gaps [10].

● Step 2: Do

Implement an educational intervention that is designed address learners' educational needs and promote learner change and/or care outcomes. [9].

● Step 3: Study

Assess whether it achieved the outcomes from the quintuple aim framework (experience of care, population health, care team well-being, per capita cost, and equity) and seek data about the effectiveness of the intervention's impact [9].

● Step 4: Act

Iterative process of modifying and adapting the education intervention based on the insights about the effectiveness of the intervention to address learner needs and close gaps [10].

Understand your audience and their educational needs by conducting a needs assessment



An important first step when designing content for a CE session is to determine who the target audience is and what their educational needs are. Identifying these needs can be achieved through conducting a needs assessment. **Needs assessments** help define the gap between current and desired professional practices and/or care outcomes for health professional learners and their patients [12-13]. Data derived from the needs assessment can be used to develop educational objectives and inform methods of delivery [12-13].

The following are different types of learning needs that can be addressed through a needs assessment:

Self-recognized or perceived needs	Unknown or unperceived needs	Miscalculated or misperceived needs	Emergent needs
I know what I want and need to know	I don't know what I don't know	I think I know something that I don't	Now I have some new information, I realize I want or need to learn something else instead of or in addition to what I am learning now

Methods for conducting a needs assessment



The best way to know what learners perceive as their learning needs it is to ask them directly [13]. However, learners are not always aware of their learning needs. Unperceived needs can be identified through experts in the field, patients and clinical data. The following are common methods of conducting needs assessments:

Determining perceived needs- "I know what I want and need to know"

Survey	A questionnaire is delivered to the target audience to determine what potential participants may want or need to know [13].
Focus groups	An interview conducted with several representatives of the target audience led by a facilitator to gain insight into participants' views and opinions [13].
Key informant	A delegate from the target audience talks with their colleagues, gathers information on perceived learning needs and then reports to the CE planner [13].
Additional methods	<ul style="list-style-type: none">• Interviews• Meetings with colleagues (formal or informal)• Evaluations of previous CE activity

Determining unperceived needs- "I don't know what I don't know"

Expert advisory group	Process where experts in CE or clinical practice are asked questions about their program and content preferences [13].
Chart audit	A method that systematically examines patient charts and EMR/EHR data looking for patterns of care that can be appropriate or inappropriate [14].
Input from patients	Data on patient satisfaction and experience can be captured to identify learning needs. This information can be gathered through interviews, surveys, and including patients on planning committees [14].
Additional methods	<ul style="list-style-type: none">• Knowledge tests• Critical incident reports• Direct observations of practice performance

Practice: Identify the gap



Needs assessments help define the gap between current and desired education practices for your target audience [12-13]. Identification and analysis of educational needs can provide the foundation for developing educational objectives. In this exercise, identify the educational or professional gap that the CE session will address.

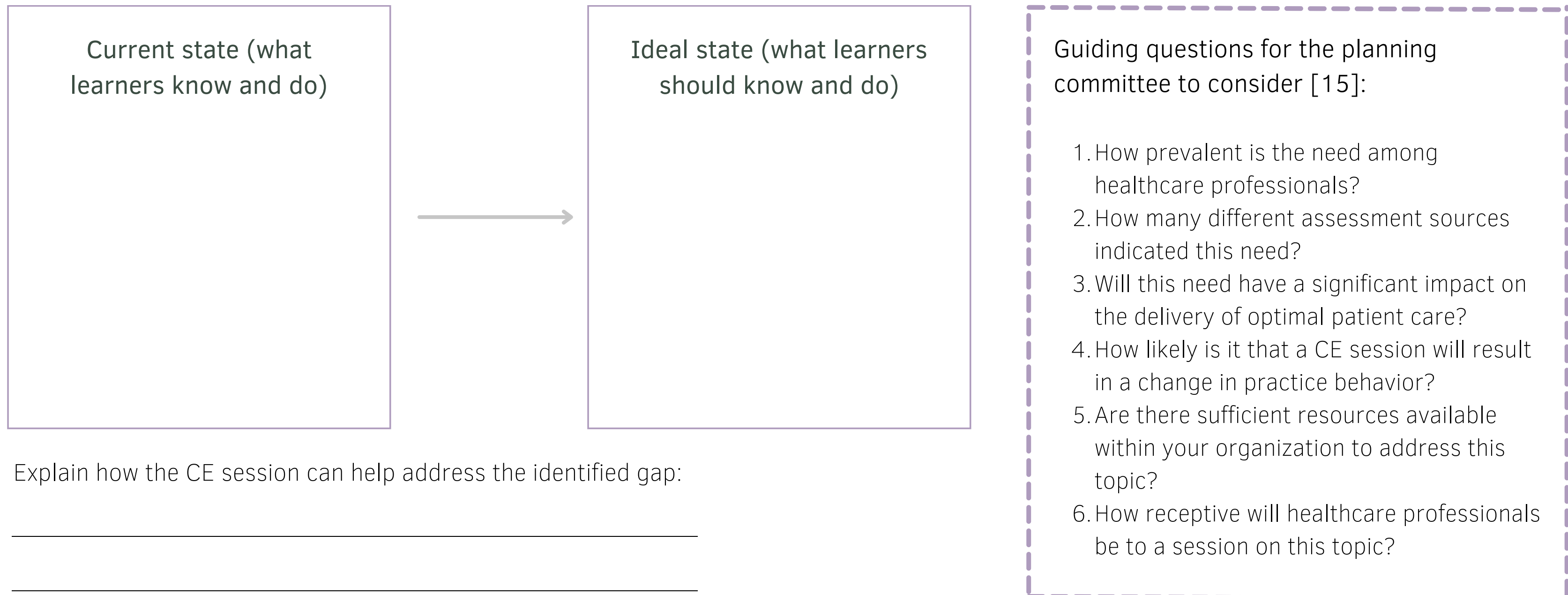

2.2 Develop targeted learning objectives

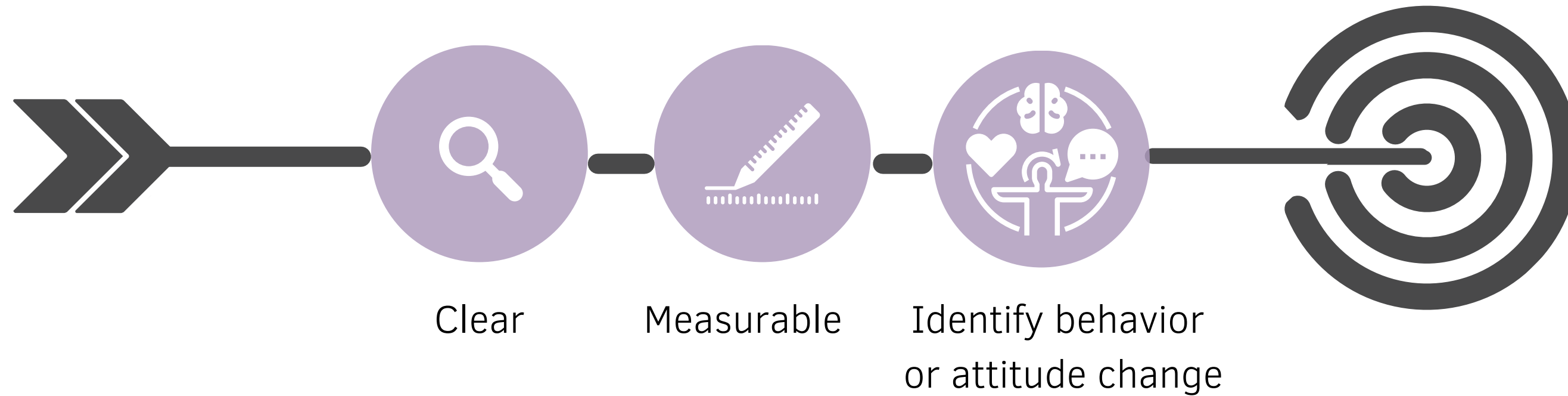

Learning objectives should clearly state, in measurable terms, the behavior or attitude the learner is expected to adopt on completion of the activity.

- ✓ Use verbs based on [Blooms' Taxonomy](#) to structure clear learning objectives ([See page 34](#)) [16].
- ✓ Employ the [TACT](#) (target, action, context, and time) principles to articulate the expected behavior or attitude change in clinical practice and how it can be measured ([See page 36](#)) [16].

How to write a learning objective

Learning objectives should reflect the desired knowledge, skills, and abilities that learners should develop as a result of participating in your CE session. Bloom's Taxonomy describes the types of knowledge and cognitive processes used by learners. When writing a learning objective, first establish which type of knowledge (left side of the table on [page 33](#)) you wish your learner to acquire. Using this type of knowledge, next determine which cognitive process (top of the table) you wish to focus on in your instruction. Bloom's Taxonomy increases in rigor from left to right [17a]. Learning objectives should be written using action verbs that target the desired combination of knowledge and cognitive process to make it clear to learners what changes they should expect upon completion of the CE activity [17]. Framing learning objectives in this way has the added benefit of providing objective measurable indicators of behavior that can support the demonstration of learner change. Use the following table to create targeted learning objectives. The examples provided are not exhaustive but provide a starting point for developing your learning objectives.

Bloom's Taxonomy has continuously evolved to meet the changing needs of educators. As you become more familiar with learning objectives, you may wish to explore the different versions. Please see [page 35](#) in the toolkit for additional resources.

The Taxonomy Table [17a]

		The Procedural Dimension				
The Knowledge Dimension	Remember	Understand	Apply	Analyze	Evaluate	Create
Factual Knowledge	The learner will list symptoms of juvenile diabetes	The learner will summarize the functions and features of a new medical device	The learner will complete a surgical safety checklist	The learner will be able to differentiate the clinical presentations of acute rhinosinusitis vs acute bacterial rhinosinusitis to develop treatment plans	The learner will rank risk factors in terms of severity for COVID-19	The learner will create a personal quick guide for identifying patients with a higher risk for stroke
Conceptual Knowledge	The learner will recall the differences between Crohn's Disease and Ulcerative Colitis	The learner will explain why they would recommend a particular anti-depressant drug for a patient	The learner will apply the four pillars of medical ethics to a patient situation	The learner will distinguish which patients to prioritize in a triage situation	The learner will critique the effectiveness of different managerial styles	The learner will design a treatment plan for a person living with cancer
Procedural Knowledge	The learner will list the key factors in effective team management	The learner will explain how to complete a successful kidney transplant	The learner will perform a tracheal intubation	The learner will attribute a successful surgical operation to the specific methods used	The learner will check their implementation of a vascular stent	The learner will create step by step plan onboarding new team members

Commonly used verbs [17b]

The following are commonly used verbs for each level of Bloom's Taxonomy. While there are many others, this chart is a helpful jumping-off point [17b].

Knowledge	Understand	Apply	Analyze	Evaluate	Create
List	Explain	Use	Analyze	Judge	Construct
Recall	Describe	Apply	Compare	Appraise	Design
State	Paraphrase	Demonstrate	Distinguish	Rearrange	Arrange
Name	Discuss	Act	Differentiate	Compare	Organize
Label	Translate	Solve	Categorize	Assess	Plan
Define	Summarize	Illustrate	Contrast	Evaluate	Compare
Repeat	Classify	Operate	Examine	Synthesize	Create
Identify	Express	Sketch	Relate	Defend	Develop
Cite	Interpret	Dramatize	Infer	Estimate	Formulate
Select	Infer	Employ	Test	Manage	Write

Additional Resources

Learning Objectives



Krathwohl, D. R., Bloom, B. S., & Masia, B. B. (1964). Taxonomy of educational objectives: The classification of educational goals, Handbook II: Affective domain. New York: David McKay Co.

Dave, R.H. (1970). Psychomotor levels in Developing and Writing Behavioral Objectives, pp.20-21. R.J. Armstrong, ed. Tucson, Arizona: Educational Innovators Press.

Harrow, Anita J. (1972). A Taxonomy of the Psychomotor Domain: A Guide for Developing Behavioral Objectives. New York: David McKay Co.

Simpson, E. J. (1972). The classification of educational objectives in the psychomotor domain: The psychomotor domain. Vol. 3. Washington, DC: Gryphon House.

How to **make** a learning objective **actionable**

TACT (target, action, context, and time) is a mnemonic that refers to principles that can be used to structure your learning objective so that it clearly articulates the expected clinical behavior or attitude change [16]. Creating an actionable learning objective is important to direct learners through the CE intervention and for facilitators to stay focused on the goals of the CE intervention [16].

Please refer to the following example on the right when you are creating your learning objectives.

As part a CE session on colorectal cancer screening awareness ...

1

TARGET

Whom is the learning objective directed toward?

Primary care physicians

2

ACTION

What is the behavior or attitude change required?

To implement recommendations on screening for colorectal cancer among the average-risk population aged 50 to 74 years

3

CONTEXT

Where is the behavior or attitude change taking place?

In their clinical practice

4

TIME

What is the time frame to demonstrate behavior or attitude change?

Within the next three months

Example Learning Objective: Implement recommendations on colorectal cancer screening among the population between the ages of 50 to 74 years in family physician's clinical practice within the next three months.

Practice: Write a learning objective



TACT Principle	Learning Objective
TARGET Whom is the learning objective targeted toward?	
ACTION What is the behavior or attitude change required?	
CONTEXT Where is the behavior or attitude change taking place?	
TIME What is the time frame to demonstrate behavior or attitude change?	

Write your learning objective based on the TACT principles.



2.3 IDEA principles

Inclusion, diversity, equity, accessibility

The IDEA principles of inclusion, diversity, equity, and accessibility acknowledge learners' identities, demographics, learning preferences and needs, experiences, and professional backgrounds that should be considered and applied when providing a learning opportunity [18].

These principles should be applied in the preparation, implementation, and evaluation stages. In order to ensure the plans are aligned with (and responsive to) the diverse needs of the learning community, it is imperative that representative voices be heard and incorporated into the educational planning.

The IDEA principles should also be incorporated when considering planning committee composition, location, and/or context. They should also be applied toward understanding the relationships and histories embedded within these systems that may affect the success of a learning intervention.

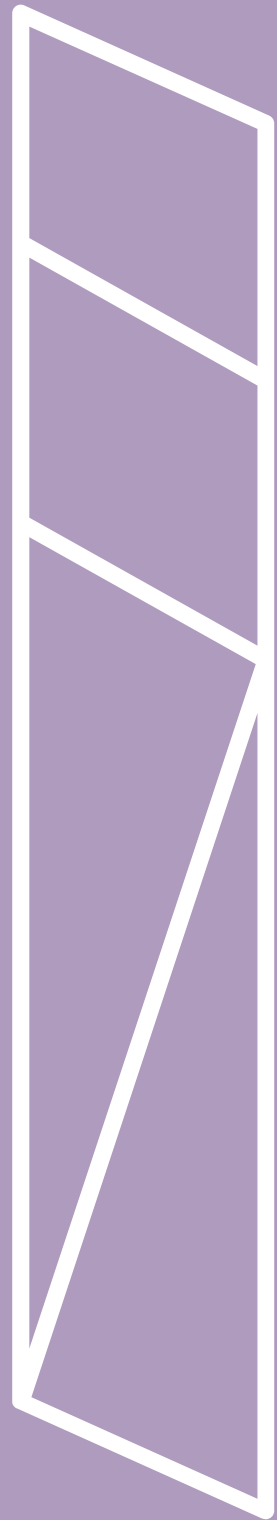

Designing for inclusivity

Using inclusive and respectful language is an important component of program design as this influences the development of collaborative relationships in both learning and clinical spaces [18].

Planning committees, if you have one, optimally should seek representation and/or feedback from diverse stakeholders (including those with lived experience and their families) as learning interventions are developed to ensure inclusive language and attentiveness to constructs such as gender, race, ethnicity, age, ability, sexual orientation, and profession or discipline [18].

Culturing an inclusive learning environment will be an important goal of facilitation. Setting ground rules early on in a program is helpful [18].

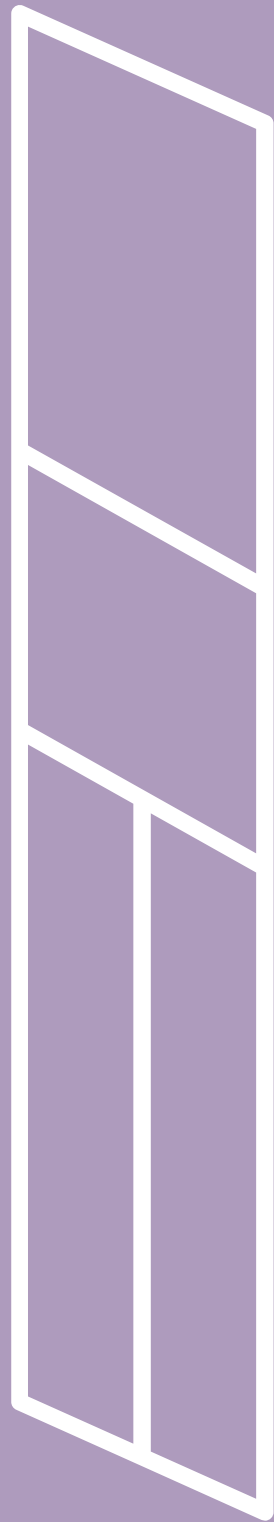

Designing for diversity

Developing authentic learner-centered experiences includes paying attention to the diversity of learner needs and the diversity within real-life examples or group dynamics. Representing authenticity in examples or scenarios will be an important piece in achieving impact [18].

Acknowledging that learners (and planners or facilitators) have diverse lived experiences and learning preferences can inspire planners to develop a broad variety of learning activities. For example, planners may wish to seek out examples from under-represented/marginalized populations, ensuring that stereotypes are eradicated, and biases are removed, minimized, and/or declared [18].

In program delivery, for example, visual or audio tasks can be accompanied by written transcripts to account for learners with diverse learning needs or preferences [18].

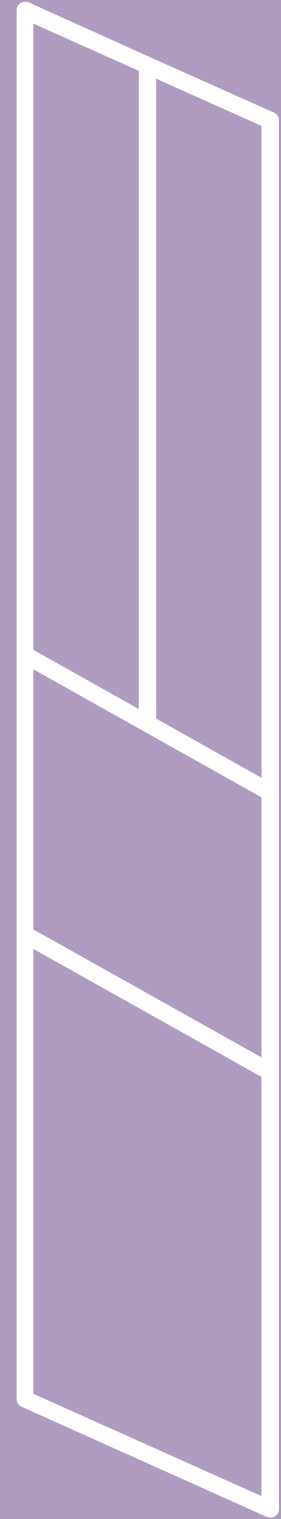

Designing for equity

Designing for equity means that developers work to address the differences between individuals and population groups that are systematic, unnecessary, unfair and avoidable [18].

When facilitating learning opportunities, consider broadening perspectives from the individual to the institutional level, taking into consideration advantages some may access or burdens some may be unable to avoid [18].

Consider designing activities that support equity-based improvements in program or service delivery, decision making, or resource allocation [18].

Designing for accessibility



Accessibility is an important consideration in both content development and education delivery.

Bringing examples related to accessibility into small group, reflective, or case-based activities allows for the learner to include accessibility as a consideration [18].

The increased use of virtual platforms to deliver case-based learning can promote accessibility by reaching a larger target audience. However, it is critical to consider access to network bandwidth and the burden of cost, especially for remote and marginalized areas [18]. Additional considerations include assistive devices for learners with audiovisual challenges, strategies to facilitate physical limitations, and language translation when appropriate.

Furthermore, the technology used for virtual, blended, or hybrid learning sessions needs to be perceived as easy to use and accessible to encourage learners to actively participate [18].

IDEA considerations when designing your CE intervention [18]

INCLUSION

- ✓ Does your intervention plan use inclusive and respectful language?
- ✓ Are the facilitators using inclusive language when addressing learners?
- ✓ Do you seek representation or feedback about your activities and materials from diverse stakeholders?
- ✓ Do the facilitators have a clear guideline on how to set ground rules and expectations?

DIVERSITY

- ✓ Do your materials represent and respect the diversity in your population?
- ✓ Are the context, backgrounds, experiences, and needs of learners considered in the CE session design?
- ✓ Do you engage diverse stakeholders when vetting your CE content?
- ✓ Is your content free of stereotypes and bias associated with gender, race, ethnicity, culture, religion, age, sexual orientation, ability, and other identities?

IDEA considerations when designing your CE intervention [18]

EQUITY

- ✓ Do your learning objectives target systemic and structural issues or individual-level issues?
- ✓ Does your content prompt equity-based improvements to clinical care?
- ✓ Does your CE content consider the experiences and needs of vulnerable or marginalized groups?
- ✓ Are your facilitators unbiased, objective, and inclusive?

ACCESSIBILITY

- ✓ Will your CE session be conducted in-person or virtually?
- ✓ Do your CE session activities address scenarios pertaining to access?
- ✓ Are there different methods to access the CE session materials to participate?
- ✓ If you are using a virtual platform, is it easy to use and understand?

2.4 Key considerations for virtual CE delivery

As virtual delivery methods become more prominent, consider the following strategies when designing your CE intervention:

1

Minimize disruptions to the flow of the session by providing technology requirements prior to the session.

2

Assign a second facilitator to help learners offline with technical issues.

3

Encourage learners to stay on camera and prompt them to change their screen name so that it reflects their preferred name.

4

Breakout rooms can employ self-managed facilitation to guide discussion or a facilitator can be present in each breakout room to monitor the discussion.

5

Facilitators should provide clear guidelines and task-oriented instructions when learners are engaging in virtual breakout rooms.

2.5 Additional resources

Needs assessment



- Mann KV. Not another survey! Using questionnaires effectively in needs assessment. Journal of Continuing Education in the Health Professions. 1998;18(3):142-9. doi:[10.1002/chp.1340180303](https://doi.org/10.1002/chp.1340180303)
- McCawley PF. Methods for conducting an educational needs assessment. University of Idaho. 2009;23: 6-14. <https://www.extension.uidaho.edu/publishing/pdf/bul/bul0870.pdf>
- Michener Institute of Education at UHN: [A Guide to Performing Needs Assessments](#)
 - *Tip sheet on methods and tools for performing needs assessments among learners*
- Grant J. Learning needs assessment: assessing the need BMJ 2002; 324 :156 doi:[10.1136/bmj.324.7330.156](https://doi.org/10.1136/bmj.324.7330.156)

Learning objectives

- Association of American Medical Colleges (AAMC): [Writing Learning Objectives](#)
 - *Tip sheet outlining the steps for writing a learning objective and how to use Bloom's Taxonomy*
- American College of Surgeons Division of Education: [Tips for Writing Learning Objectives](#)
 - *Tip sheet with explanation and examples of how to write learning objectives*

IDEA principles

- Centre for Addiction and Mental Health (CAMH): [Health Equity and Inclusion Framework for Education and Training](#)
 - *Report outlining a framework for integrating equity and inclusion into the planning, development, and implementation of educational initiatives*
- ACCME: [Advancing Social Justice Resources](#)
 - *Webinar and additional resources about how to integrate equity, diversity, and inclusion principles into CE sessions*

Additional resources

Virtual delivery considerations



- ACCME: [Best practices for planning and leading virtual meetings – tips for faculty](#)
 - *Tip sheet for facilitators using online learning tools*
- Harvard University: [Best practices for teaching remotely](#)
 - *Website outlining course types and tips for teaching through virtual and blended methods*
- Royal College of Physicians and Surgeons of Canada: [Ten tips for virtual teaching](#)
 - *Tip sheet identifying strategies for virtual teaching*
- Temerty Faculty of Medicine University of Toronto CPD: [Tips for use of ZOOM technology for digital learning](#)
 - *Tip sheet for using Zoom to facilitate a videoconference session*
- Temerty Faculty of Medicine University of Toronto CPD: [Virtual synchronous teaching using Zoom \(interactive webinar\)](#)
 - *Webinar on tips for synchronous teaching and applying interactor features on Zoom*
- Dr. Heather MacNeill: [Synchronous teaching and learning](#)
 - *Youtube channel about online learning, effective teaching principles, co-facilitation, and interactivity using Zoom*
- The University of Minnesota: [Online course design resources](#)
 - *An online course that instructs how to develop remote teaching plans, assignments, and assessments*

Educational interventions for CE sessions

SECTION THREE

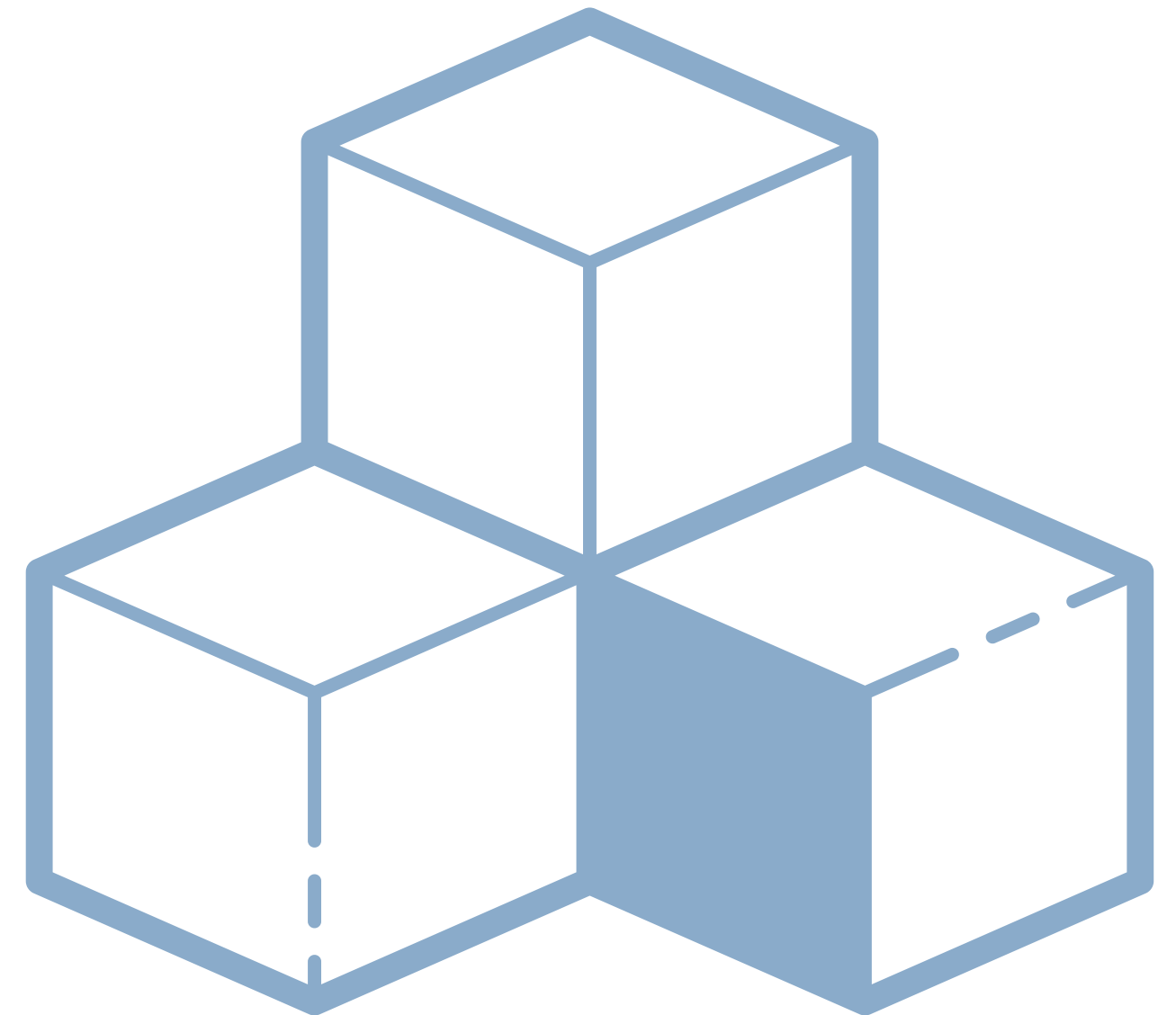

3.1 Facilitation of small group learning

INTERVENTION ONE

Small group learning: an instructional approach that encompasses active participation, purposeful activities, and face-to-face interaction. It is a concerted and collaborative effort in learning new knowledge and skills, and attaining a mutual objective [19].



In this subsection:

Introduction to small group learning

- Why small group learning?
- Case scenario
- Guiding questions
- Key enablers
- Formula for success

Framing the problem and preparation

- Plan out discussion
- Mind map
- Strategies for creating an inclusive, safe and supportive space

Implementation guidelines

- How to facilitate small group learning
- Maintaining group dynamics
- Role of facilitator
- Approaches to encourage discussion
- Questioning strategies
- Debrief checklist

Key considerations

- Tips for in-person and virtual delivery
- Challenges with facilitating small group learning sessions
- Mitigating challenges

3.1.1 Introduction to **facilitating small group learning**



In this module, you will learn how to prepare and implement facilitation strategies for small group learning interventions. These facilitation guidelines can be used in combination with other educational interventions to deliver integrated CE sessions.

Key Terms:

Group Dynamics: The behavior and attitude patterns involved when learners interact with each other [20].

Mind Map: A creative and logical method of note-taking and note-making that maps out your ideas [21].

Why facilitate **small group learning**?

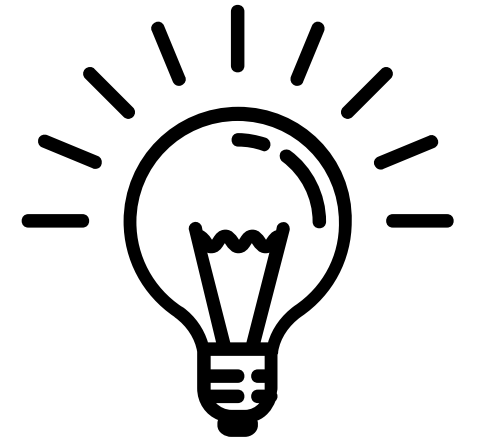

Small group learning is an advantageous education intervention for CE sessions. Through promoting a collaborative and **team-oriented** environment, learners develop skills in problem-solving, team building, decision making, and critical thinking [20,22]. Learners engaged in small group learning activities constructively work together to attain a mutual objective and build their own understanding in conjunction with peers [20]. The main goal of small group learning is to have a **learner-driven session** rather than an instructor-led one, however, the facilitator plays a crucial role in the success of a small group learning intervention by fostering a supportive environment to encourage group engagement and collaboration [19,20]. Effective **facilitation** strategies are an indicator of productive CE sessions [20].

Case scenario

An organization has been developing a collaborative care model for patients with both mental and physical health challenges. This model is a new way of working for the organization and poses several significant challenges for the health professions team. Katrina, a CE leader, has observed the need for educational support in achieving their clinic's new goals. In Katrina's planning for a CE session, several committee members have suggested that they include small group learning to improve collaborative goal setting and increase completion rates of patient-reported outcome measures. These areas are essential for implementing a collaborative care model.

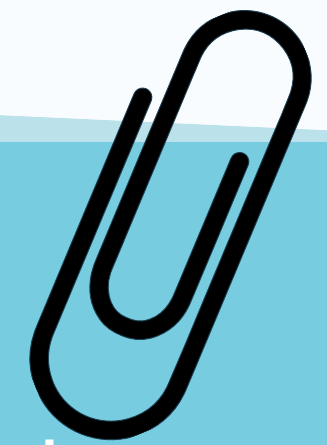

As Katrina is planning her small group learning session, she encourages facilitators to consider the following questions:

1	What are the important principles and considerations for small group learning experiences you should consider? How comfortable are you with this type of learning format?
2	What steps are necessary to create a safe, inclusive, and collaborative space for learners? How confident are you in achieving this?
3	How would you manage group dynamics and prompt discussion?
4	How would you identify and mitigate barriers to participation? Could you manage unexpected events that come up?

Key enablers

INTERVENTION INTRODUCTION



Targeted
planning

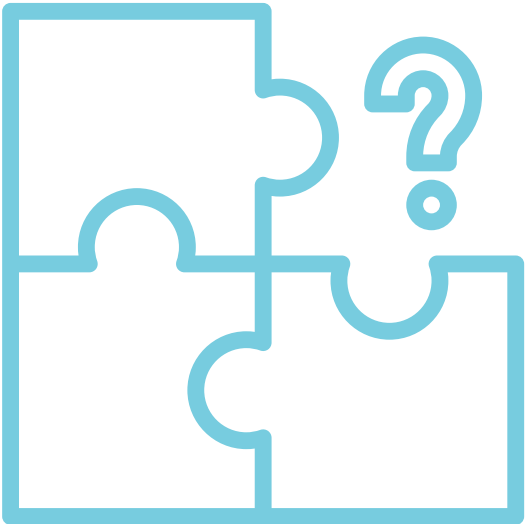

Question
effectively



Balanced
facilitation

Targeted **planning**

Planning is crucial to the success of a small group learning activity. It is sometimes seen as the most important role for facilitators. During planning, facilitators should outline learning objectives and have a plan to foster a safe and productive learning environment [23-25]. Additionally, factors such as time, space, and recruiting faculty should be considered in the planning phase [23].

Learning objectives that guide a small group learning intervention should be clear, measurable, and identify a behavior or attitude change [24].

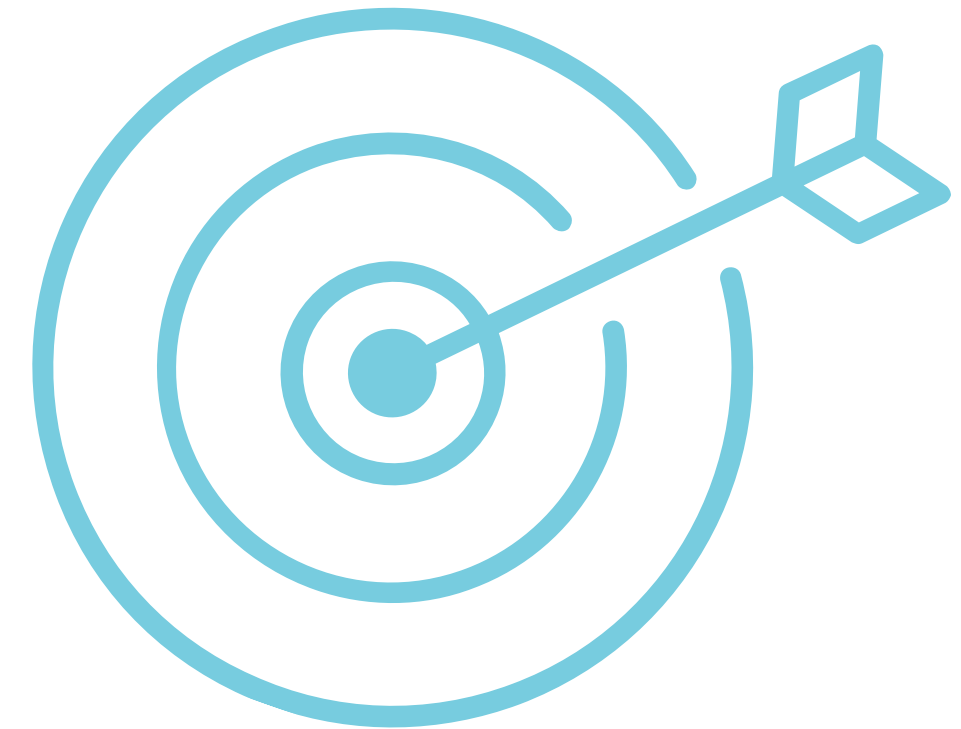

Question *effectively*

Questions allow the learners to evaluate their understanding of key concepts [24].

The facilitators play a pivotal role by asking thoughtful questions, actively listening, and responding positively to learners. Questioning allows facilitators to understand the learner's needs, monitor progress, and provide support [20,24].

Questioning is crucial in establishing a meaningful learning experience.

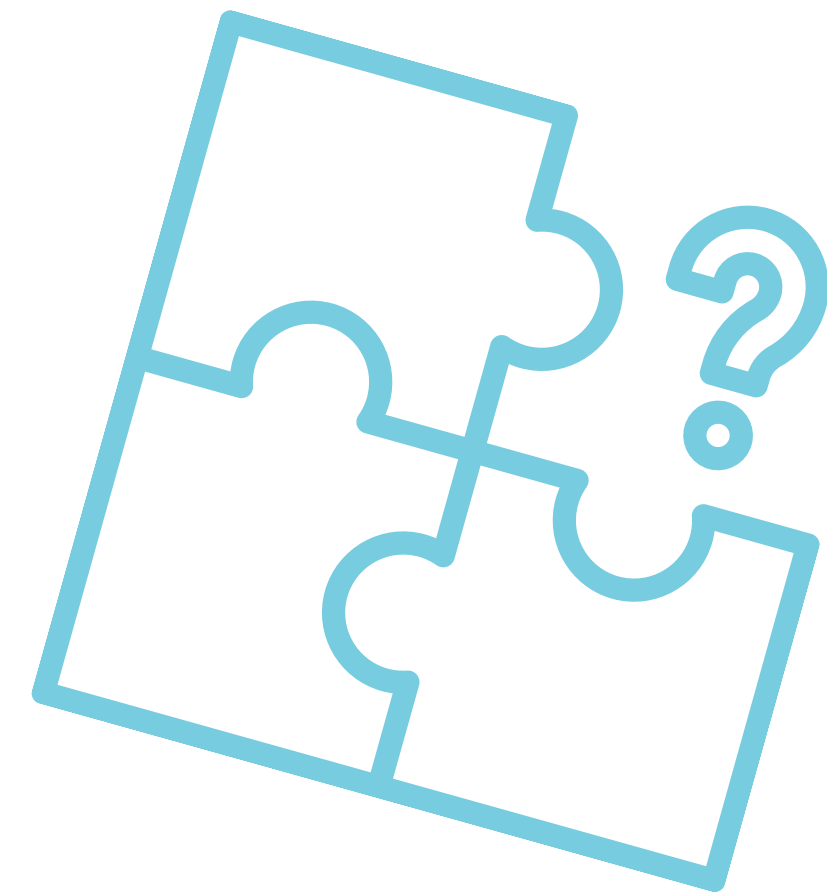

Balanced facilitation

Effective facilitation is a balance between encouraging learners to lead the conversation and understanding when it is appropriate for the facilitator to provide guidance [20,25-26].

Effective planning through targeted learning objectives and mind mapping can help facilitators balance when to guide and when to listen. This can help learners achieve the desired mastery of the material and support gaps in knowledge that arise during group discussions [25].

Note: See [page 62](#) for a definition of mind mapping.



Formula for success

- 1 Identify facilitators, select time, space, and delivery modality for the CE session.
- 2 Facilitators should create a small group to focus on individualized learning needs and encourage active learning.
- 3 Facilitators should ensure group dynamics that foster inclusion, fairness, and critical reflection on constructive feedback.
- 4 Facilitators should prompt discussion, understand learners' progress, stimulate curiosity, sustain and initiate conversation among learners, and outline follow-up action plans.



Facilitating small group learning

3.1.2 FRAMING THE PROBLEM AND PREPARATION

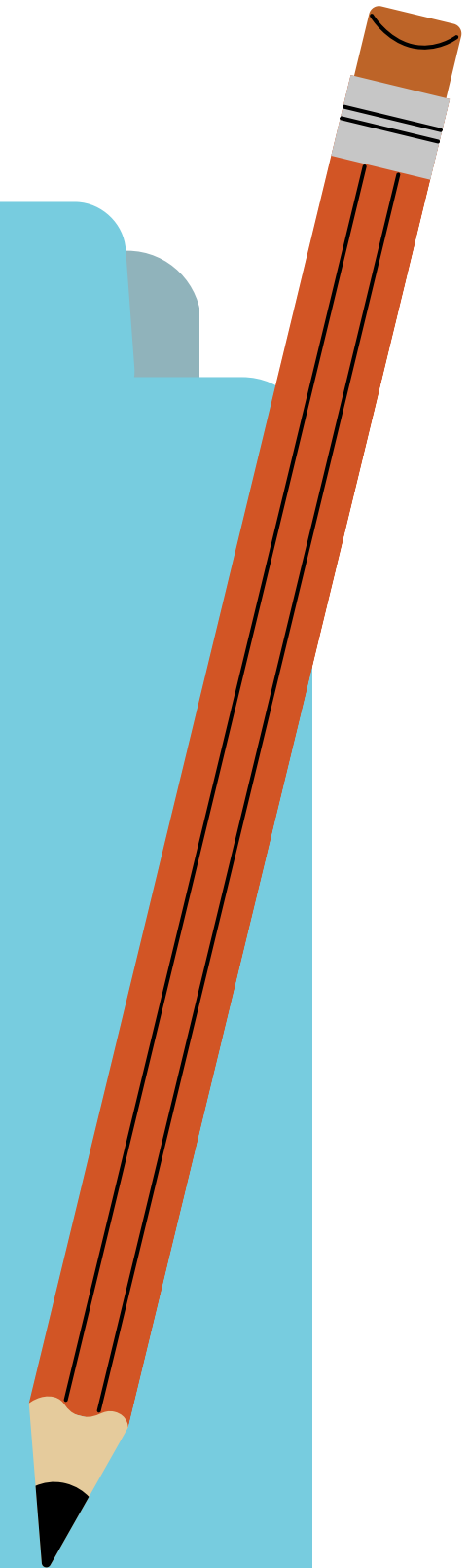
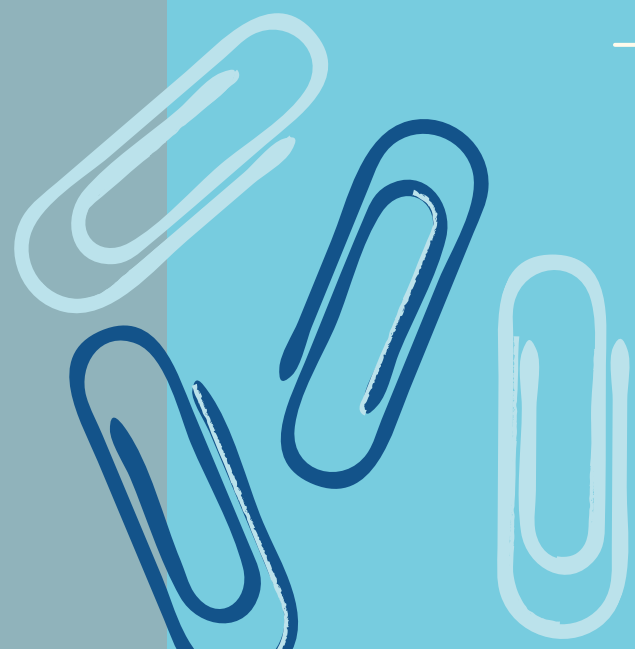



Planning your **small group discussion**



Just as it is important for learners to arrive in a small group well prepared, it is equally important for the facilitator(s) to have properly planned and anticipated ways to engage learners in discussion [19-20,22-29].



Consider creating group sizes between 4 and 5 learners in a virtual setting or 6 to 8 learners in an in-person setting. These group sizes allow the facilitator to focus on individual learning needs, tailor content, and encourage active participation [19-20,23-24,29].



Mind mapping can be used as an informal technique to organize a facilitator's discussion points for a small group session and during the learning session to summarize key points [21].

Mind map: A teaching resource

Mind mapping



Mind mapping is a creative and logical method of note-taking and note-making that maps out your ideas [21]. Facilitators can use it as a teaching resource to:

- ✓ Prepare and review CE sessions
- ✓ Prepare questions
- ✓ Facilitate small group discussions

HOW TO PREPARE

Prepare and review CE sessions

- Summarize information from different sources into key topics and keywords [21].
- Map them to identify how they are interrelated [21].

Prepare questions

- Write the session topic down in the center of the page and follow up with subsequent sub-topics or questions around the topic [21].
- Re-draw or tidy up the map and group similar topics together [21].
- Use this method to identify key questions for discussion [21].

Facilitate small group discussions

- Summarize key points and action items discussed during a learning session [21].
- Visually depict how the discussion evolved [21].

How to create a mind map

For Katrina's CE session on the novel collaborative care model at her organization, she creates the following mind map to structure the group's discussion:

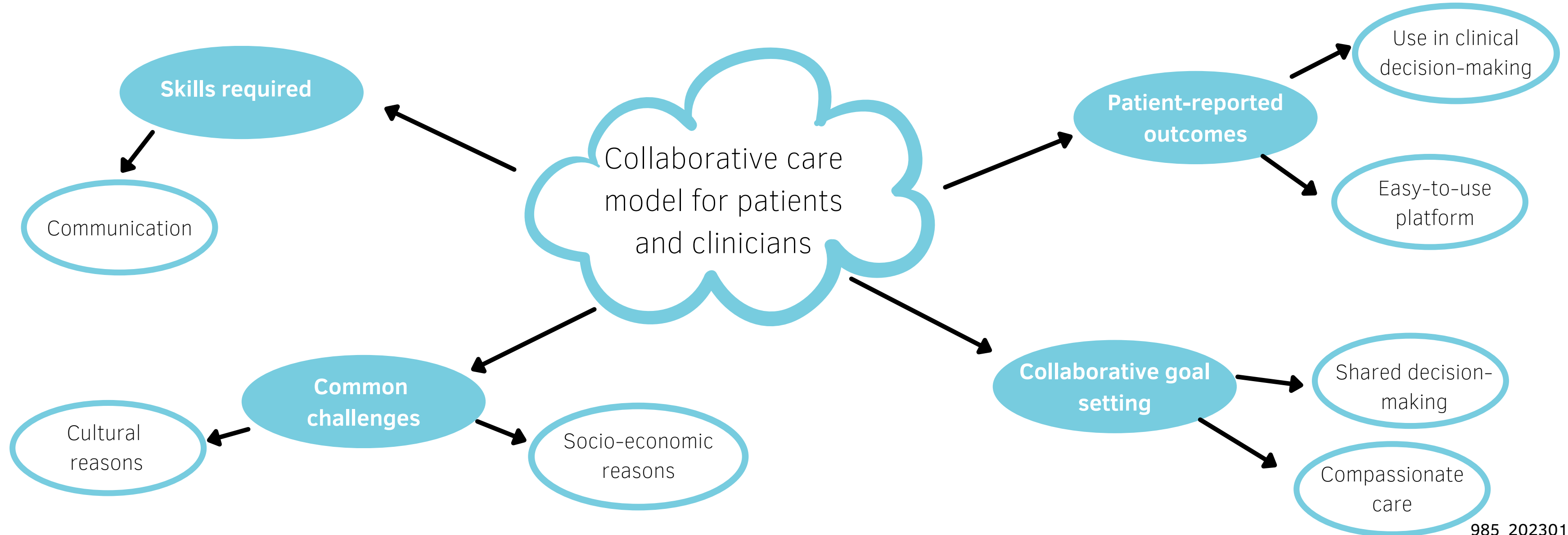

HOW TO PREPARE

Practice: Create a mind map

Mind maps can be a useful tool in planning out your session's discussion and identifying key concepts that you want learners to take away from the CE session. Use the following template to create a mind map for your CE session.

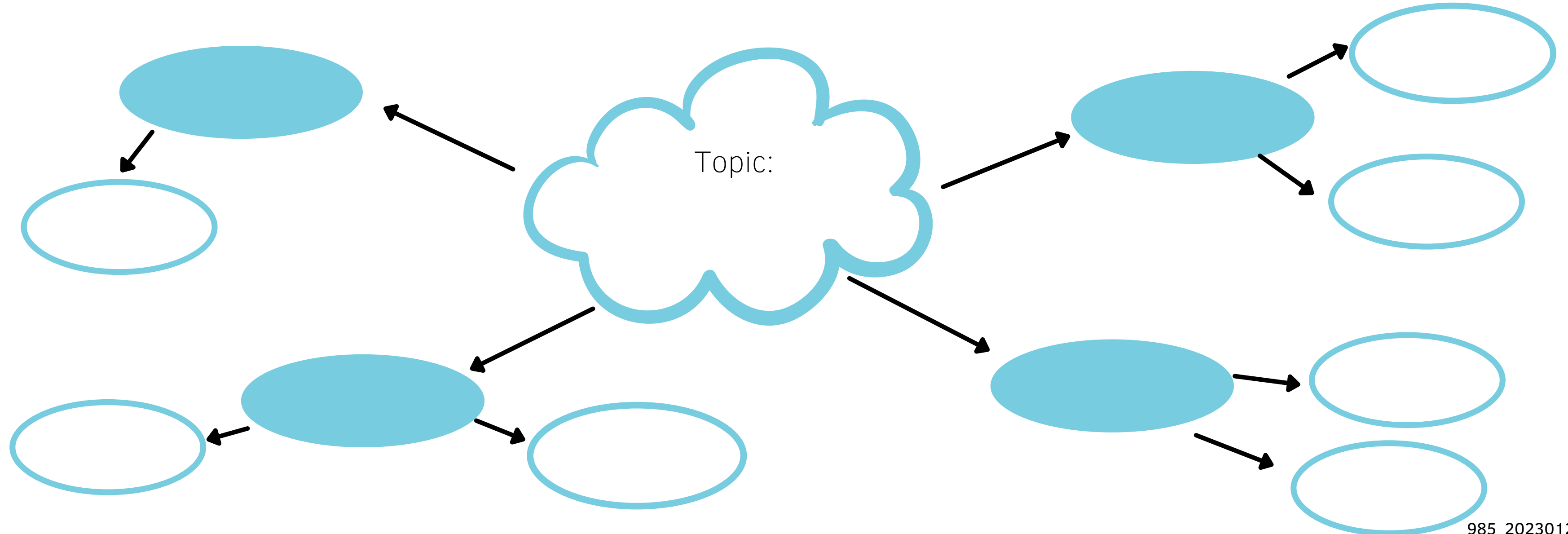

HOW TO PREPARE

Creating an **inclusive, safe, and supportive** space

An important step in planning your CE session is to consider how the facilitator will foster an **inclusive, safe, and supportive environment**. Creating a space where learners can be themselves and feel respected and not judged is necessary to encourage engagement amongst learners. Integrating strategies for **inclusion** within your CE sessions provide opportunities for learners to have meaningful participation in discussions.

For developing a CE session on the novel collaborative care model, Katrina considers strategies for creating an inclusive space to ensure that learners are comfortable, actively engaged, and participatory. The next page explores strategies Katrina can use to foster a safe learning environment.



Strategies for creating an inclusive, safe, and supportive space



CONDUCT INTRODUCTIONS

Allow time at the beginning of the CE session for brief group introductions. This is an important step to allow the group to become familiar with each other [20].



SET GROUND RULES

Creating and monitoring expectations throughout the session can promote shared responsibility and respect [20].



BALANCE LEARNER TYPES

When possible, ensure groups represent an equal balance of learner types (dominant, enthusiastic, quiet) [20].



WEAR NAME TAGS AND USE TENT CARDS

Having everyone wear name tags allows facilitators to address learners by their names and builds rapport with the learners [20].



AVOID USE OF FORMAL TITLES

Facilitators should avoid the use of titles to promote an inclusive space and reduce potential disengagement due to hierarchy [20].



ROLE MODEL APPROPRIATE BEHAVIOR

As a facilitator, demonstrate good interpersonal and communication skills. Hold yourself accountable to the same ground rules as the learners [20].



MONITOR WHO IS CONTRIBUTING

Involve every learner in the discussion by moving the conversation away from dominant individuals while encouraging less dominant, quiet individuals to contribute [20].



INTERVENE WHEN NECESSARY

Encourage learners to ask and answer each other's questions before intervening or providing guidance [20].



PROVIDE POSITIVE FEEDBACK

Positive reinforcement of constructive contributions promotes a supportive environment and encourages learners to continue participating [18].

Example of ground rules

Ground rules help learners understand acceptable behaviors during the CE intervention. They make the role of the learner clear in order to stimulate the best environment for learners [30]. If time permits, it can be a useful exercise to engage the group in creating the ground rules. As Katrina is designing the CE session, she identifies the following ground rules that will be introduced at the beginning of the small group learning session:

- 1 Be on time
- 2 Be respectful of others' ideas and opinions
- 3 Be empathetic and considerate of others
- 4 Be involved in the discussion
- 5 Be patient and wait for your turn to share your ideas
- 6 Be objective and share only factual information
- 7 Avoid posting or sharing inappropriate materials
- 8 Ensure confidentiality
- 9 Be careful with humor and sarcasm
- 10 Critique ideas, not people

Framing the problem and preparation checklist

THINGS TO THINK ABOUT WHEN PREPARING FACILITATION OF SMALL GROUP LEARNING

- Check to confirm that the content is relevant and suitable for attendees.
- Develop targeted learning objectives that are concise, measurable, and identify a specific behavior change.
- Create group sizes between 4 and 5 (virtual environment) learners or 6 to 8 (in-person) learners.
- Plan out discussion points using a mind map prior to the small group learning intervention.
- Consider ground rules that you want to incorporate into your CE intervention.
- Consider how to create a safe, inclusive, and supportive environment.
- If you are conducting the intervention virtually, refer to best practices for virtual delivery on [page 45](#).

Facilitating small group learning

3.1.3 IMPLEMENTATION GUIDELINES

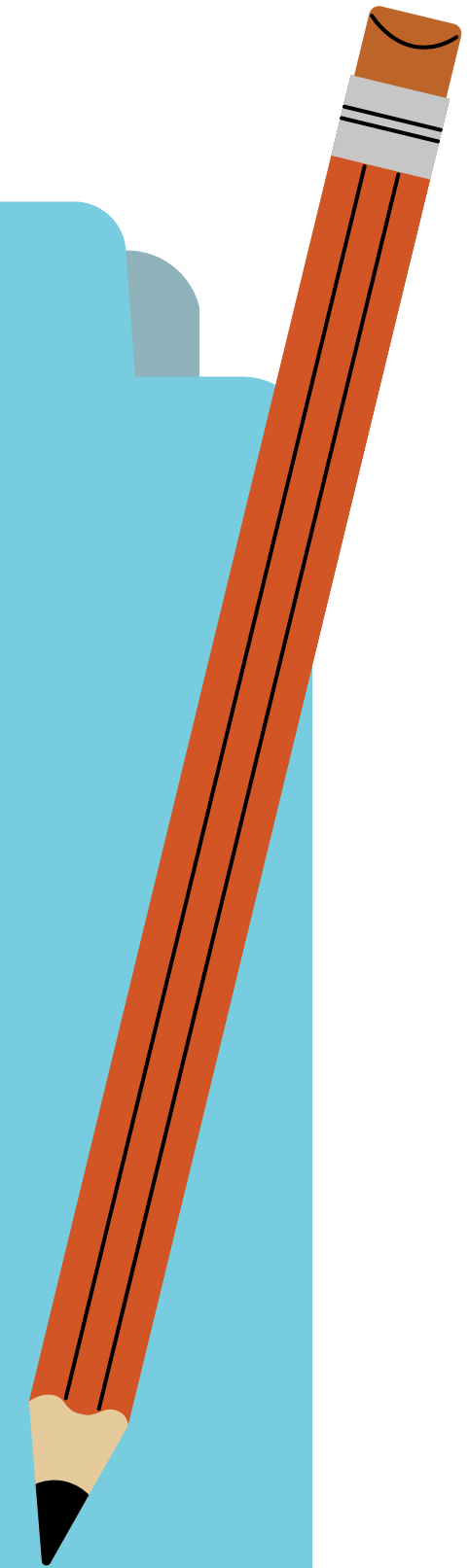
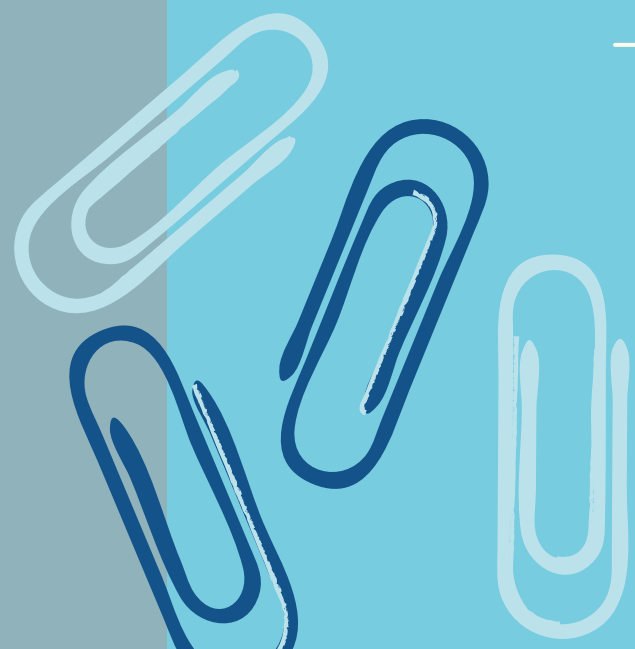

How to facilitate **small group learning**

1

Briefing



Introduce concepts and learning objectives [20]

2

Group dynamics

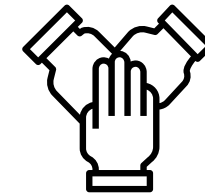

Foster a safe, inclusive, and supportive space [20]

3

Leading activities

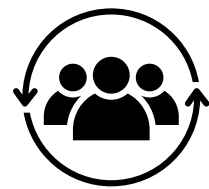

Prompt discussion and gauge learner progress [20]

4

Debriefing



Close session and deliver knowledge assessment [20]



Briefing checklist for small group learning

- Set the stage for the session and activity.
- Facilitate introductions and icebreakers.
- Outline the objectives and provide overview of the session.
- Review ground rules and expectations of behavior.

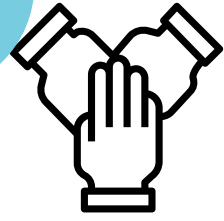

Importance of maintaining group dynamics

1

Understanding and maintaining group dynamics are important skills for a facilitator. A facilitator should start the CE intervention by outlining guidelines and ground rules that will help create a positive group learning environment. The facilitator should then continue monitoring the group to ensure mutual respect is being upheld and there is equal participation among group members. Facilitators need to be aware of and then mitigate disagreements if they are escalated [26,31].

2

Tuckman's stages of small group development explain how group dynamics evolve through the duration of a small group learning intervention. Facilitators play an important role in guiding each stage and can use Tuckman's stages to structure their facilitation technique as well as manage group dynamics [20,32-33].

2



How to guide learners through Tuckman's stages of small group development

TUCKMAN'S STAGE

FACILITATOR ROLE

1

FORMING

The initial formation of the group and getting acquainted [20,32-33].

- Lead introductions and icebreakers, outline objectives, and provide an overview for the session [20,32-33].
- Facilitator needs to be directive to provide structure for the team and clarify expectations [20,32-33].

2

STORMING

Group actively performs the task; however, some conflict may emerge [20,32-33].

- Facilitator coaches the learners by helping them focus on goals and expectations, managing the process and conflict, generating ideas, and explaining decisions [20,32-33].

3

NORMING

Develop consensus and begin to focus on team goals [20,32-33].

- Facilitator provides encouragement, helps to build consensus and gives feedback to the group [20,32-33].

4

PERFORMING

The team is mature, well functioning, and focused on problem-solving [20,32-33].

- Facilitator has a non-interfering role because tasks and objectives are delegated among the group [20,32-33].
- Facilitator provides alternate perspectives and uses questioning techniques to engage learners' critical thinking [20,32-33].

5

ADJOURNING

Group successfully worked together and documented results [20,32-33].

- Facilitator engages learners in the reflection process by asking questions and providing feedback to the learner group [20,32-33].
- Facilitator is receptive to feedback from the learner group and uses feedback to adjust facilitation approach in future sessions [20,32-33].

HOW TO IMPLEMENT

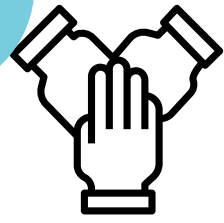

Role of facilitator during small group learning

Consider the following tasks when conducting a small group learning intervention to maintain group dynamics and encourage the flow of discussion:



Prepare learning materials

- Support the activities and learning process [20].
- Outline guidelines and expectations [20,25].



Summarize discussion

- Explain and provide guidance when necessary [20].
- Highlight the group's progress and identify key points that were discussed [25].

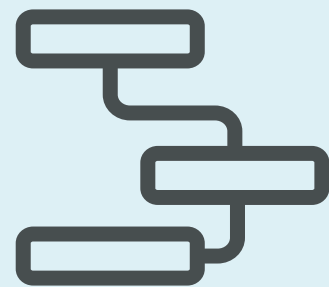

Provide a structure

- Keep the group on task and focused on the topic [25].
- Ensure the session runs on time by monitoring discussion and tabling discussions that run long [19].



Develop learners' thinking

- Prompt learners with open-ended questions [20,25].
- Encourage learners to move beyond memory recall and mobilize critical thinking skills [20,25].



Engage learners in discussion

- Ensure active participation of learners [19-20,25].
- Monitor and support learners' progress [20,25].



Safe and supportive space

- Maintain group dynamics by upholding guidelines [19-20].
- Take steps to ensure learners feel comfortable and safe participating [19-20].

3



Facilitator techniques to encourage small group discussions

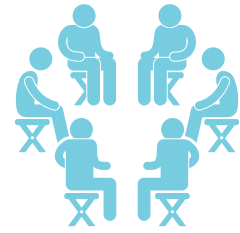

Seating arrangements

When providing large activities, avoid using large desks, which can inhibit interaction among learners [16-17]. A circular arrangement can promote eye contact among learners and improve engagement [20,25].



Snowball groups

Learners form pairs and discuss a topic, then increase group size to four learners to discuss the same topic [16-17]. This technique increases the comfort of learners by starting off in a smaller pair [20,25].

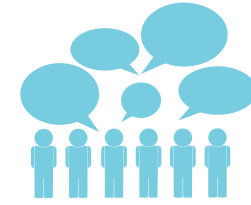

Cross-over groups

Useful in larger groups and if the topic has multi-facets. In the first stage, subgroups discuss one facet [16-17]. Then in stage 2, the subgroups are reformed so that each new subgroup contains representatives from all the stage 1 groups [20,25].



Write/Pair/Share

When posed with a question, learners formulate their thinking in writing before engaging in a discussion with a partner. The pair then shares their ideas with the group [20,25].



Buzz groups

Brief discussions in small groups where learners talk among themselves. The facilitator monitors, drops by and listens but does not actively participate in the discussion [20,25].



Role play

Group members act out a scenario. This technique allows group members to directly apply content [16-17]. It allows for real-time feedback and for group members to develop a sense of self-efficacy [20,25].



Importance of questioning for small group discussions

Aim of questioning



Understand the needs of learners and provide adequate support [20,25].



Stimulate curiosity; sustain and initiate conversation among learners [20,25].

OPEN-ENDED QUESTIONS

Capture in-depth responses, allowing the facilitator to ascertain the learners' comprehension of topic, **problem-solving ability**, and thinking skills [20,25].

CLOSED-ENDED QUESTIONS

Yield a specific answer to the question, enabling the facilitator to **check the knowledge** of learners but not their level of understanding [20,25].

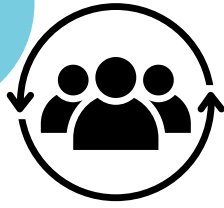

Questioning technique for facilitators

Use the following questioning technique to prompt discussion and gauge learner progress. Silence can feel uncomfortable but should be welcomed as it allows learners time to process the question, think, and formulate a response [20]. With this approach, avoid immediately rephrasing the question or answering the question yourself [20].



POSE

Pose an open-ended question to the group; e.g.,
What challenges of the collaborative care model for patients and clinicians should we consider?



PAUSE

Pause, allowing learners to reflect, and formulate a response.



POSITIVE FEEDBACK

Provide a positive response to encourage engagement.



DISCUSS

Engage learners to discuss the question with the group or in pairs.



Debrief checklist for small group learning

Consider
integrating with
Reflective
Learning
Intervention 3

- Summarize key points from discussion, unresolved questions, and important clinical links that have been made throughout the session.
- Provide feedback to learners and encourage reflection among learners.
- Be receptive to facilitation feedback from learners and adapt facilitation techniques for subsequent sessions.
- Thank learners for their contributions.

Implementation checklist

THINGS TO THINK ABOUT WHEN FACILITATING SMALL GROUP LEARNING

- Identify learning objectives, expectations, and activities.
- Modify your involvement as a facilitator based on the group's progression through Tuckman's 5 Stages of small group development.
- Provide learners with support, materials, and structure to guide them through the CE intervention.
- Utilize different activities and questioning techniques to encourage discussion.
- Encourage discussion and support differing perspectives; however, mitigate conflicts within groups if they escalate.

Facilitating small group learning

3.1.4 KEY CONSIDERATIONS

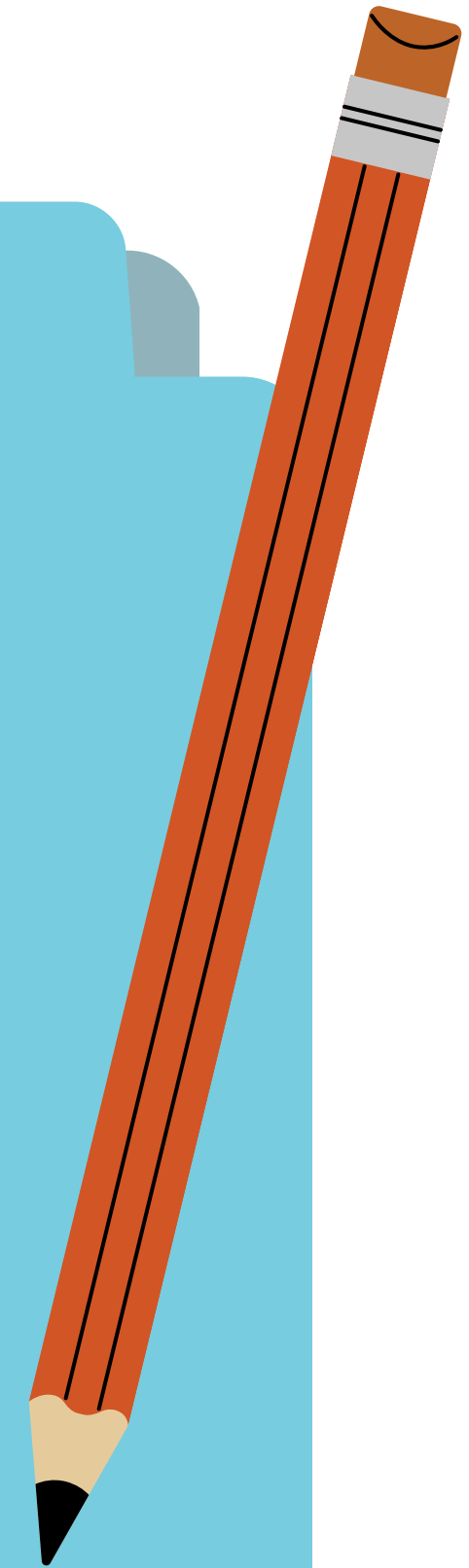
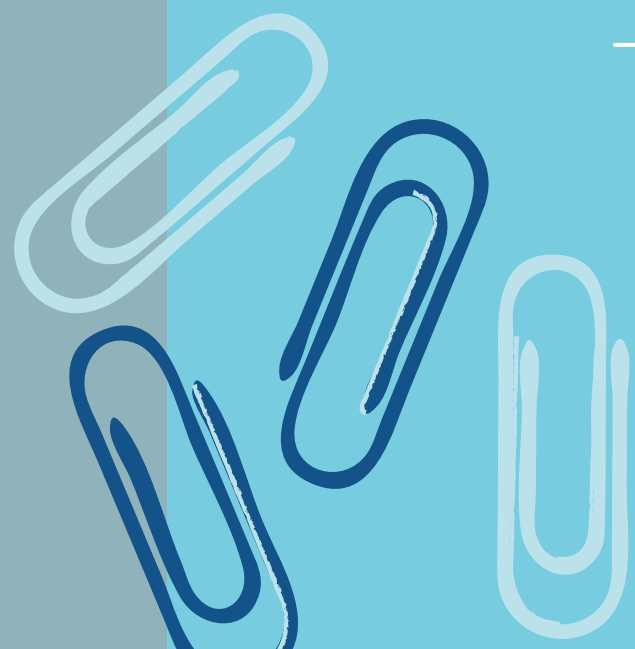

Tips for **effective delivery** of small group learning

KEY CONSIDERATIONS

	In-person delivery	Virtual delivery
Develop ground rules to foster a safe environment for learning and engagement [20,26-27].	✓	✓
Outline your expectations of the learner and have a plan to foster a safe and productive learning environment [20,26-27].	✓	✓
Communicate agenda with timelines, learning objectives, and learning materials [20,26-27].	✓	✓
Communicate technical requirements and set-up.		✓
Test video and audio quality as this can impact the level of interactivity within the group.		✓
Ensure an active and engaging learning environment for all participants [20,26-27].	✓	✓

Challenges of facilitating small group learning sessions

LACK OF A LEARNER-CENTRIC DISCUSSION

In some cases, the group is overly reliant on the facilitator to answer questions and lead the discussion [19]. The facilitator should encourage the group to work through the questions collaboratively and ask prompting questions to help guide the group's thinking [19].

MINIMAL PARTICIPATION

Small group learning is dependent on active participation to sustain discussion; however, poor preparation and disengagement can hinder critical discussion [19]. Facilitators should try engaging learners by asking direct questions to learners who look disengaged [19].

INEFFECTIVE FACILITATOR QUESTIONING

If the facilitator's questions do not rise above the level of recall, this will impact the learner's development of skills to critically analyze and problem-solve clinical issues [19]. Poor questioning techniques could also impact the flow of discussion [19].



Mitigating challenges in small group learning

Consider
integrating with
Case-Based
Learning

Intervention 2

Learners unprepared

A short knowledge test at the beginning of the session ensures the accountability of the group [20].

Learners are reluctant to participate

Facilitators can share their clinical experience to draw connections to the topic where appropriate [23]. Divide groups into pairs for the task and positively reinforce contributions [27].

Individual learners monopolize discussion

Summarize the main points discussed and divert the discussion to others by addressing the learners by their names. Provide groups with different tasks and roles to ensure equal involvement [20].

Heated discussions

Healthy discussion and differing opinions are good in order to have critical analysis; however, the facilitator should intervene when disagreements escalate [20].

Sample: Planning canvas for facilitators

KEY CONSIDERATIONS

What techniques and activities will you use to encourage discussion?

How will you work through conflicts that arise in groups?

What challenges do you anticipate and how will you mitigate them?

What strategies can you use to create an inclusive, safe and supportive space for the learners?

What group size will you choose?

How will you support groups through Tuckman's Stages of group development?

Consider how you will **evaluate** your CE session

Evaluation is an essential component of a CE session to assess knowledge uptake, identify how learners interacted with the activities, and examine whether learning objectives were effectively translated into practice. It provides an opportunity for both the facilitator as well as the learner to reflect on the session and provide constructive feedback to each other. Check out [Section Four](#) on page [155](#), which provides detailed strategies on how to assess and evaluate your CE interventions.

Consider the following questions when evaluating and assessing a CE session:

- ☑ How can I assess and evaluate the outcomes of a CE intervention by [engaging stakeholders](#)?
- ☑ What frameworks can be used to inform my evaluation questions and process ([RE-AIM](#), [Kirkpatrick-Barr](#), [Moore's framework](#))?
- ☑ What are some evaluation approaches I can integrate into my CE session ([knowledge tests](#), [semi-structured interviews](#), [feedback surveys](#))?
- ☑ How can I provide and utilize [feedback](#) to improve the CE session?

Additional resources

Further reading



- Kumar S., Deshmukh V., and Adhish VS. Building and leading teams. Indian journal of community medicine: official publication of Indian Association of Preventive & Social Medicine. 2014;39(4), 208–213. doi: [10.4103/0970-0218.143020](https://doi.org/10.4103/0970-0218.143020)
- Edmunds S, Brown G. Effective small group learning: AMEE Guide No. 48. Med Teach. 2010;32(9):715–26,. doi: [10.3109/0142159X.2010.505454](https://doi.org/10.3109/0142159X.2010.505454)
- Temerty Faculty of Medicine University of Toronto CPD: [Choosing instructional methods and integrating active learning](#).
 - Tip sheet outlining instructional methods for CME/CPD design and integrating active learning

3.2 Case-based learning

INTERVENTION TWO

Case-based learning: an educational intervention that describes when learners learn by solving real world problems [34].

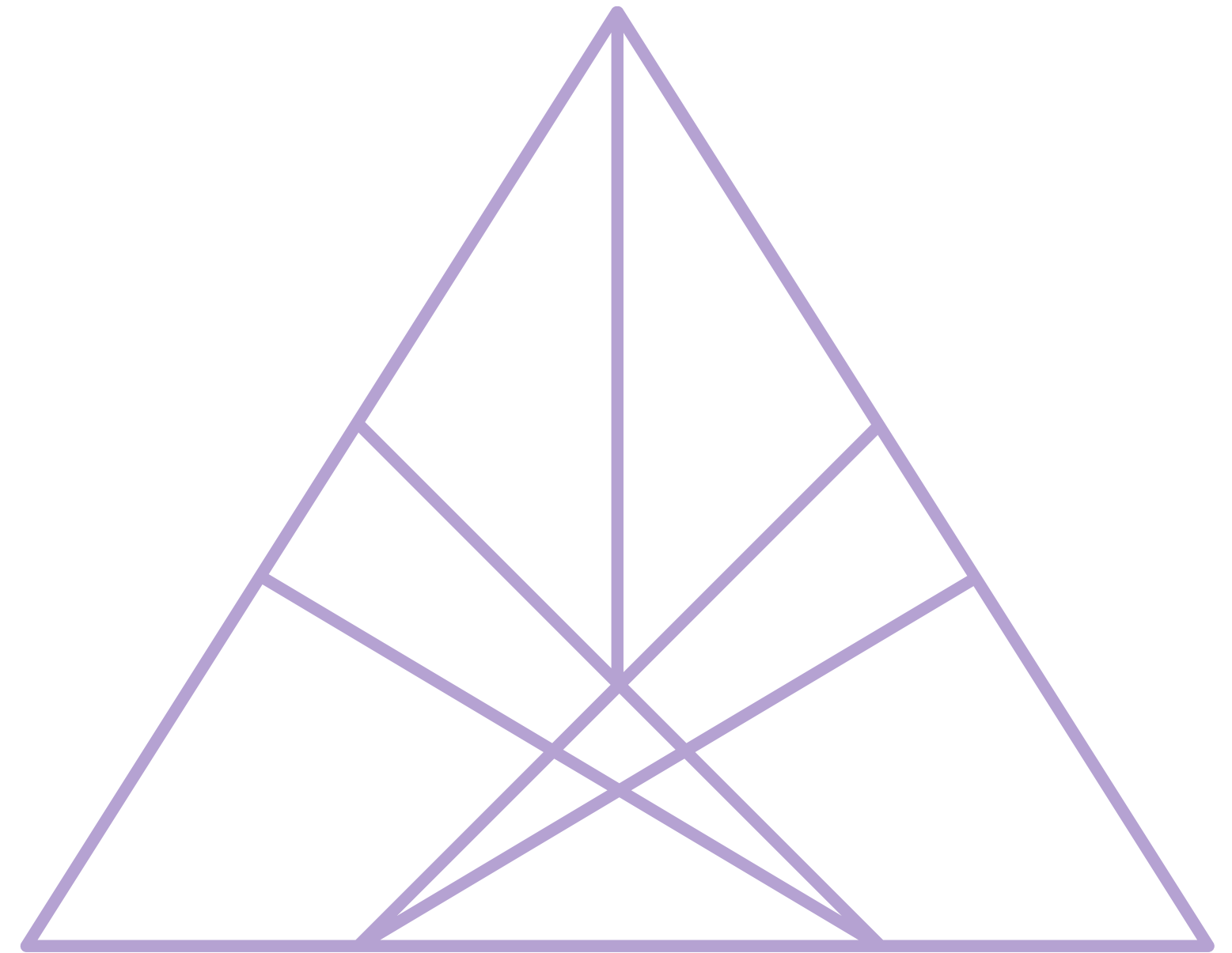

In this subsection:

Introduction to case-based learning

- Why case-based learning?
- Case scenario
- Guiding questions
- Key enablers
- Formula for success

Framing the problem and preparation

- How to develop a case
- Steps to writing a case
- Methods for presenting a case

Implementation guidelines

- How to facilitate case-based learning
- When to present the case
- Importance of facilitator's role
- Working through the cases
- Questioning
- Dissemination

Key considerations

- Group learning delivery methods
- Challenges: delivery approaches

3.2.1 Introduction to case-based learning



The previous module provided you with best practices and implementation guidelines to facilitate a small group learning CE intervention. In this module, you will learn how to prepare and deliver case-based learning, which can also be delivered effectively in a small group setting.

Key Terms:

Active learning: an instructional design approach that fosters the application of knowledge, analysis, and synthesis by engaging learners through activities such as case scenarios and problem-solving [35].

Inquiry-based learning: enables learners to actively participate and construct knowledge through a self-directed learning process and problem-solving skills [36].

Problem-based learning: fostering an interactive learning experience that establishes a context focused on clinical practice through presenting and solving real-world cases [37].

Why facilitate case-based learning?



Case-based learning (CBL) encourages learners to foster a deep approach to learning by moving from the acquisition and reproduction of knowledge to seeking meaning through the **application of knowledge** [38]. In contrast to the traditional didactic lecture-based teaching methods, CBL engages learners to analyze problems presented in authentic cases, make inferences based on information provided, and **make decisions** to **simulate real-world** professional context [39]. CBL education interventions for CE in healthcare require learners to build on their knowledge, collect clinical information, and synthesize complex information to formulate and test diagnostic hypotheses [34].

Case scenario

The COVID-19 pandemic has contributed to a shift toward a virtual care delivery model; however, this model of care poses new challenges for healthcare providers and organizations. Many healthcare providers have found it difficult to engage with patients and deliver compassionate care virtually. The organization has asked John, a director of CE, to create a case-based learning intervention to help healthcare professionals adopt virtual care for chronic pain management. Case-based learning promotes interprofessional collaboration by sharing experiences and receiving feedback from other care providers. The case-based learning intervention is intended to foster critical thinking, problem-solving, and decision-making skills among clinicians to support this new model of care.

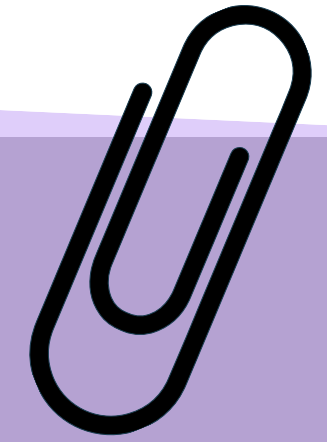

As John is developing a case-based learning session, he considers the following questions:

1	What stakeholders would I involve in the design and implementation of a realistic case?
2	How would I deliver the case to engage learners and/or how will I facilitate the sharing and problem-solving of current and active patient problems, and learning from those discussions?
3	What strategies would I employ to encourage critical thinking and reflection?
4	How would I assess learners' knowledge comprehension throughout the session?

Key enablers

INTERVENTION INTRODUCTION

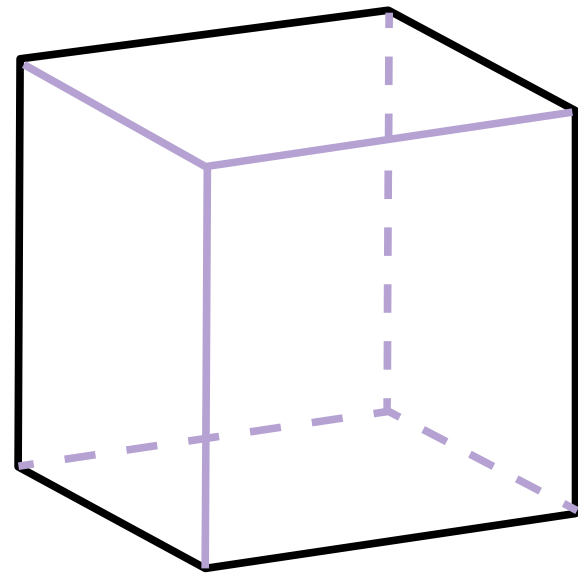

Develop
with
authenticity

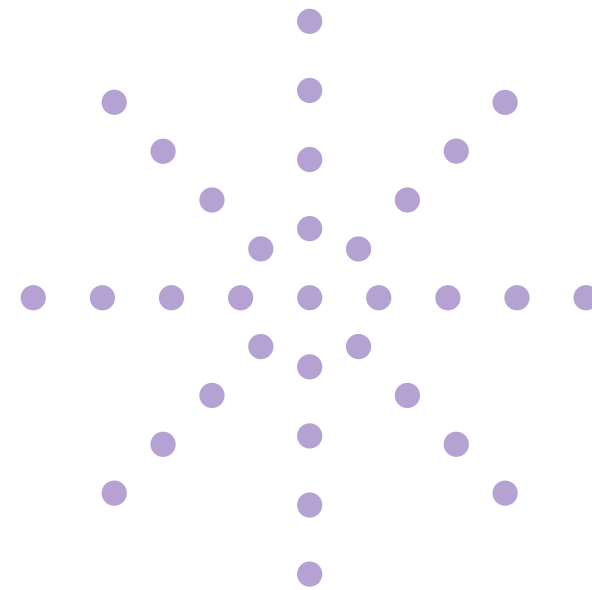

Center on an
active learner
experience

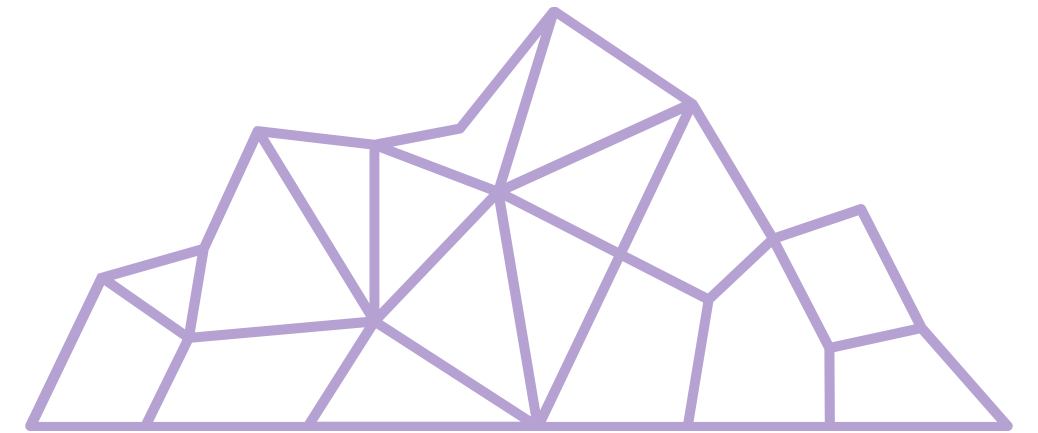

Provide autonomy
and opportunity for
improvement

Develop with authenticity

Case-based learning provides an opportunity to bring authentic experiences into the learning environment. It is important to include representative **stakeholders** in the case-study writing process [38].

When creating cases, authenticity is best achieved by staying true to a **real-world example**: include the main character with a problem that needs to be solved, describe the problem, and provide supporting data that will lead learners to ask questions [38].

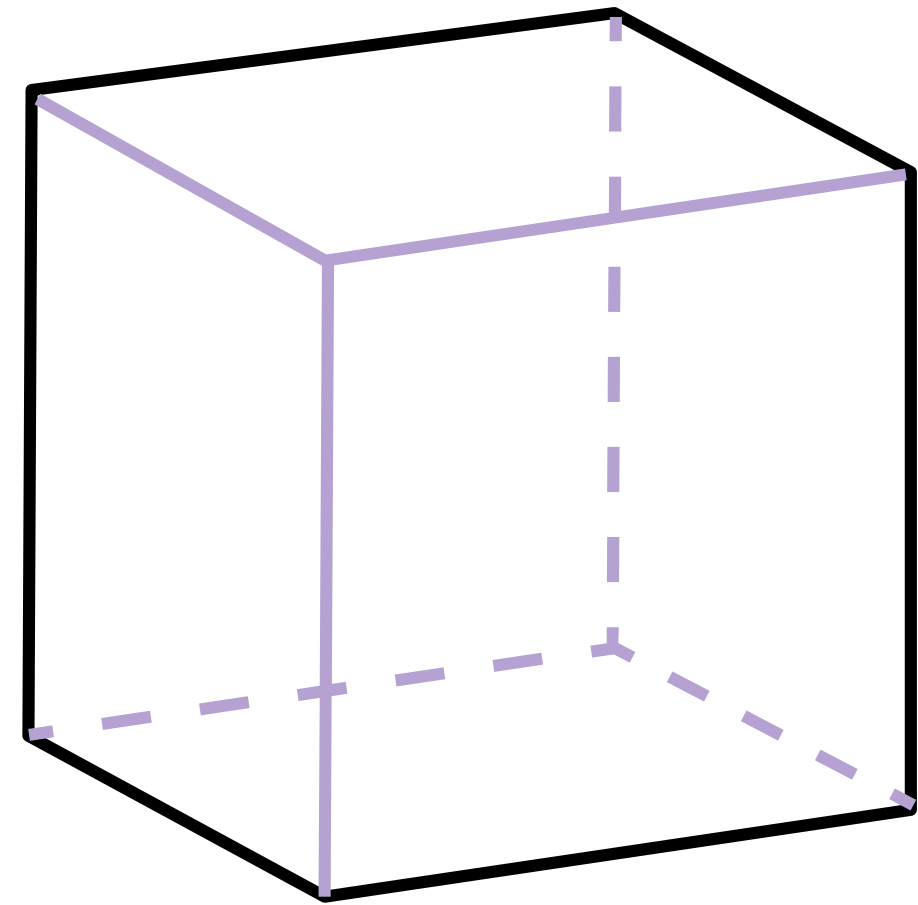

Center on an active learning experience

Case-based learning centers around an active learner experience [38,40]. Learners are provided with information throughout the case that requires them to synthesize and analyze data. The process allows learners to **make inferences** based on the information provided and **make decisions to simulate a real-world** professional context [38,40]. Concepts of team-based and inquiry-based learning are important to integrate into case-based learning opportunities [38].

Note: See definition of inquiry-based learning on [page 89](#).

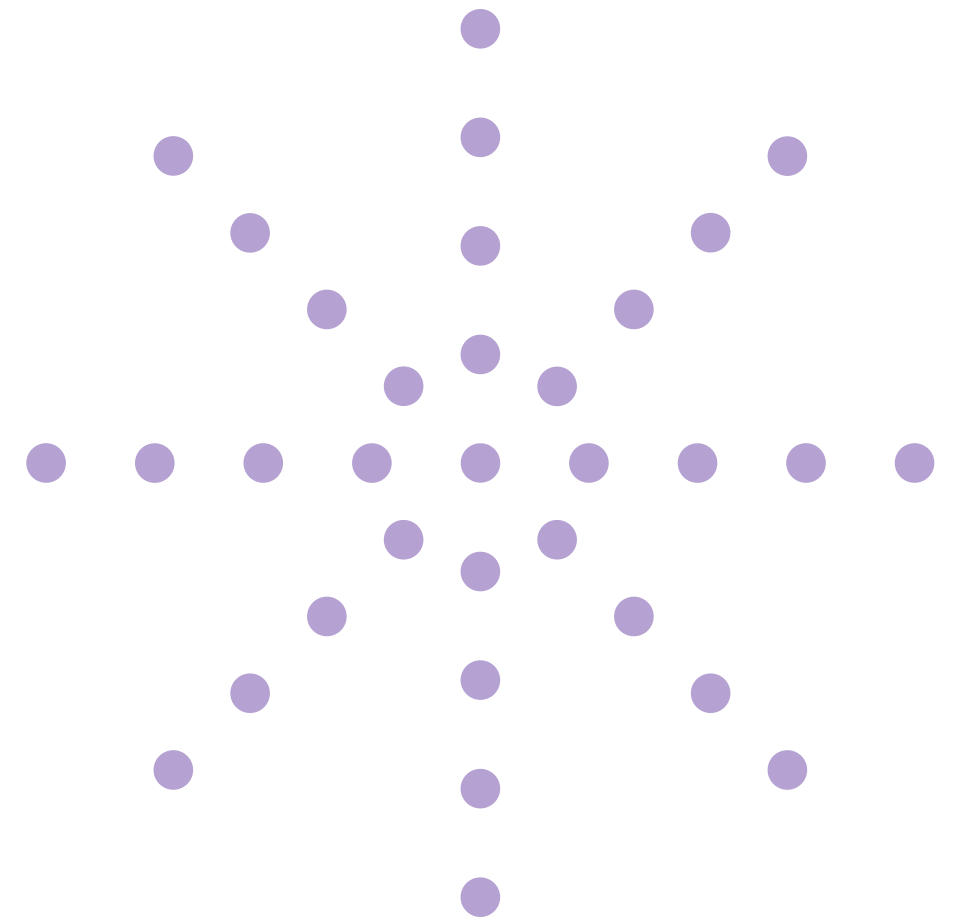

Provide **autonomy** and **opportunity for improvement**

Through effective facilitation, learners gain autonomy in their learning process. Case-based learning relies on **strong facilitation** to enable learners in their journey [38]. Prompts and questions that guide participants to describe ("what"), analyze ("so what") and propose an action ("now what") are effective facilitator tools in case-based learning that enable autonomy [38].

Knowledge tests allow learners to identify gaps and areas for improvement [38].

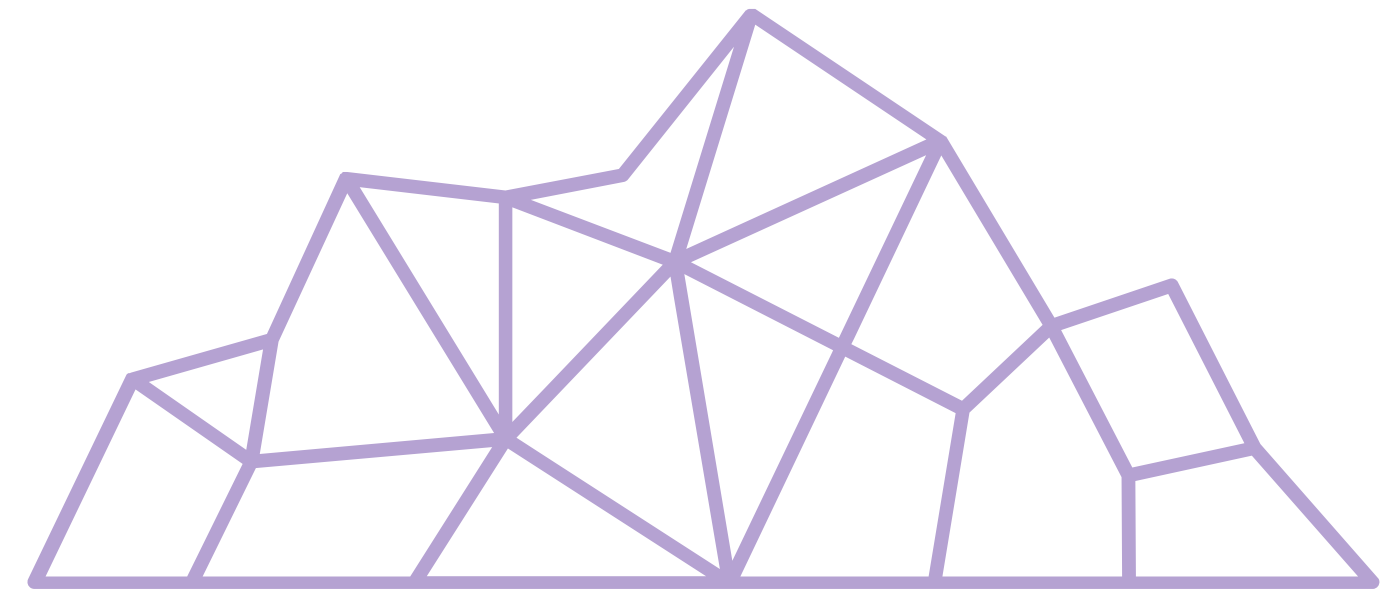



Importance of case-based learning



Clinicians learn best when they are presented with scenarios that are relevant to their type of practice and represent realistic problems that are just at the threshold of their capability.



Cases are ideal at allowing an individual learner to identify a key challenge for them that might be different than the challenges recognized by their peers. The stories of clinical cases make them compelling and memorable.



Getting feedback on sample cases is akin to using a flight simulator to learn to fly: it's important, safe, and creates lots of opportunity for practice and feedback.

Formula for success

- 1 Consult with stakeholders to help inform case writing and structure learning objectives.
- 2 Case studies should be reflective of authentic patient cases.
- 3 Select an optimal delivery method (i.e., written case, video case, didactic lecture) based on your learning objectives.

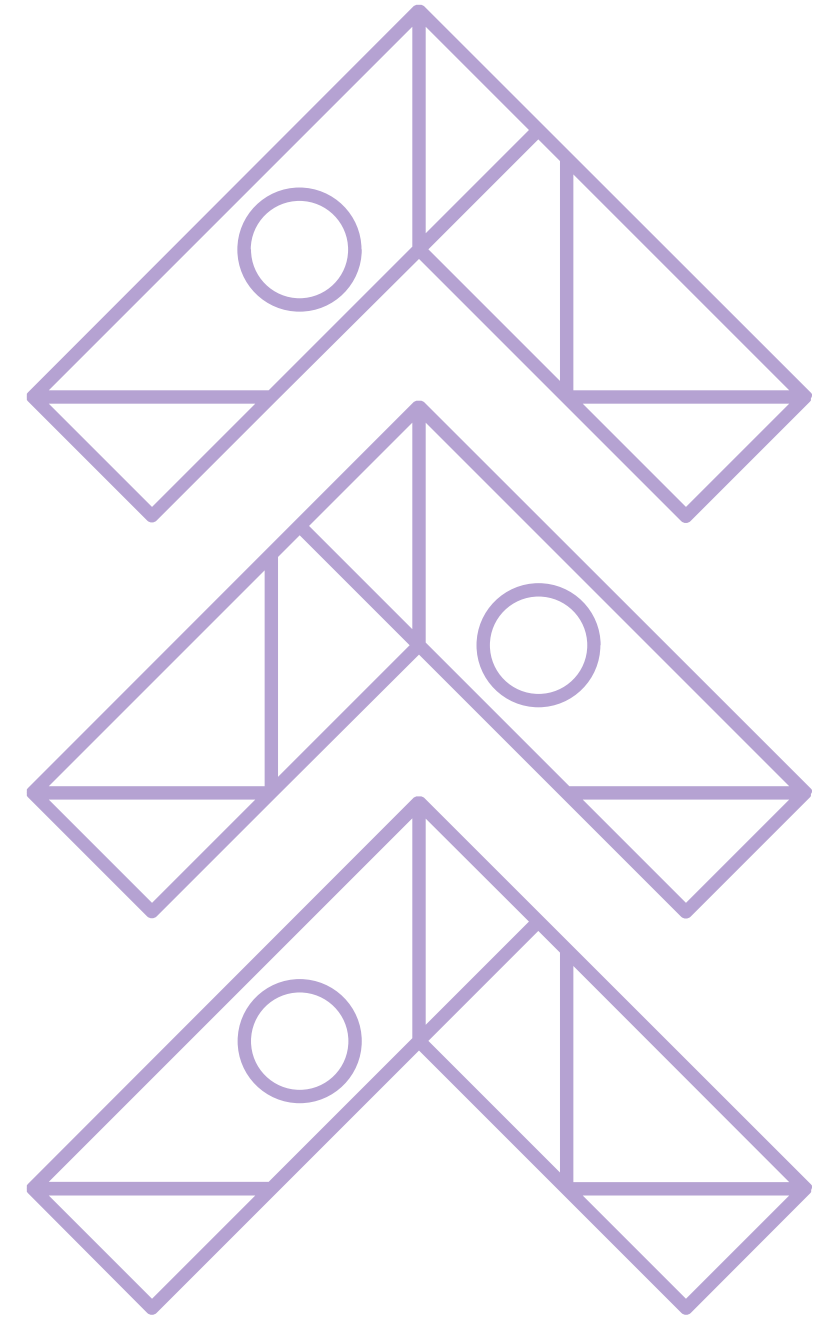

Case-based learning

3.2.2 FRAMING THE PROBLEM AND PREPARATION

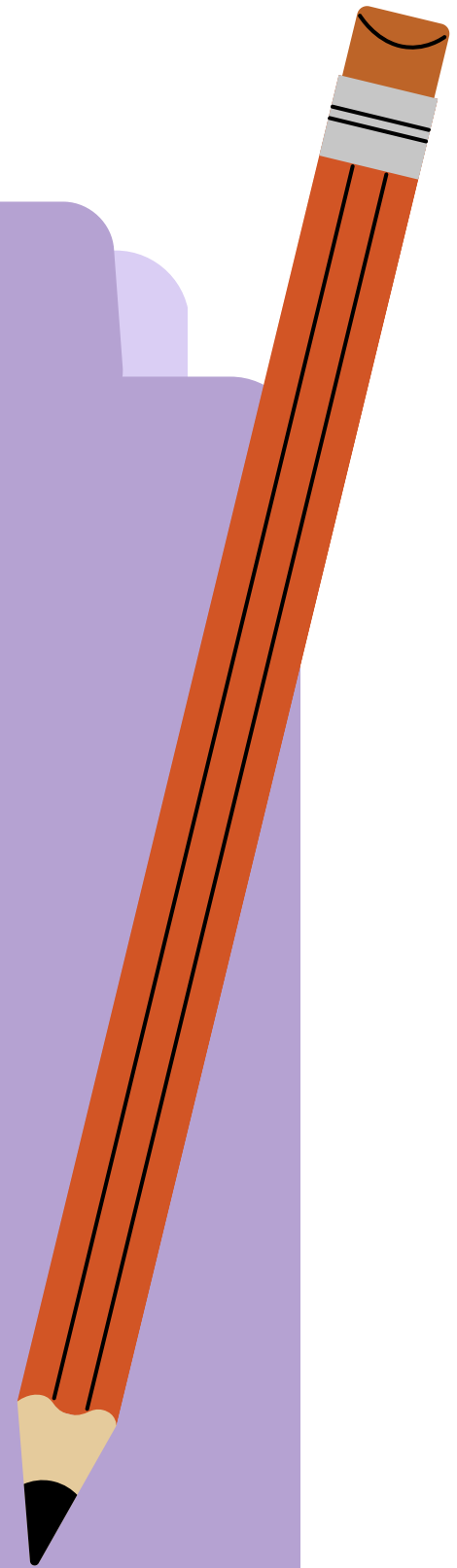
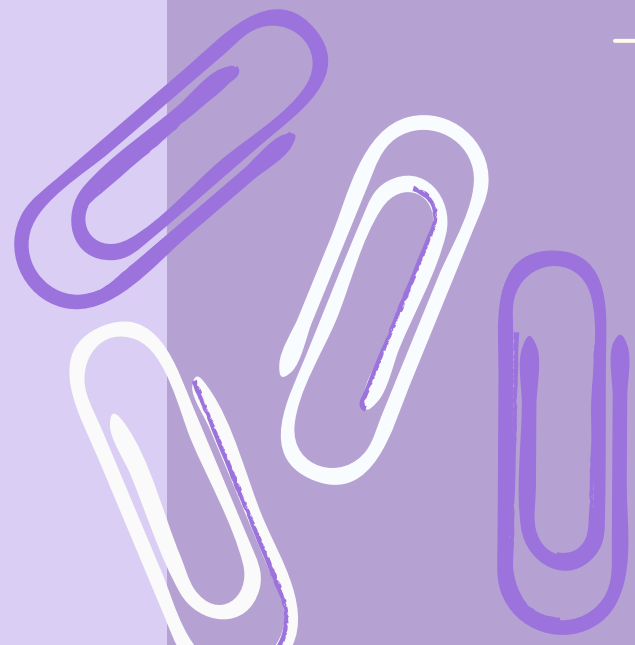

Types of Cases

There are many different types of cases that can be used as the foundation for a CE session. John considers the following approaches for facilitating a case-based learning activity:

Case Type	Description	Competency
Directed Case	Facilitator presents a case scenario to the learners, followed by a discussion. The discussion is structured based on close-ended questions [41].	Knowledge comprehension of foundational concepts
Dilemma or Decision Case	Learners are presented with a problem to work through and discuss [41].	Problem-solving and decision-making skills
Interrupted Case	Learners are presented with the case in multiple parts and are encouraged to make a decision prior to working on the next component [41].	Problem-solving skills
Analysis or Issue Case	Learners work on analyzing a retrospective case and its outcomes. They reflect on the scenario presented and engage in a discussion [41].	Analytical skills
Spontaneous Case	Learners present a scenario or problem in their current practice setting and engage in a discussion with peers to solve at the moment.	Problem-solving and decision-making skills

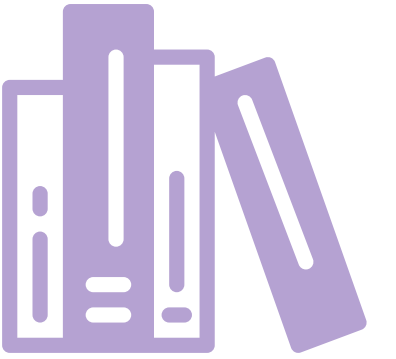

How to develop a case

Below is a common methodology for developing a case [34]; however, this is just one way to conduct a case-based learning session. Sometimes cases can be spontaneously generated by learners or the CE providers or facilitators may identify a helpful case from personal experience that helps illustrate key points.

HOW TO PREPARE

- C** Collaborative approaches to development
- A** Authentic clinical scenarios
- S** Succinct clinical scenarios
- E** Embedding the best available evidence

CASE METHODOLOGY

- Enables healthcare professionals to apply their learning in subsequent clinical practice [34].
- Structured approach that can be adapted to meet the needs of various CE programs [34].

How to develop a case



HOW TO PREPARE

Principle	Collaborative/ Interdisciplinary	Authentic	Succinct	Evidence-based
Description	Integrate an interdisciplinary approach when developing a case [34].	Develop cases that are realistic to healthcare professionals and patients [34].	Cases should be written clearly and concisely [34].	Learning materials and resources presented to resolve the case should be grounded on evidence.
Actions	Form an interdisciplinary team that includes subject matter experts, instructional designers, and clinicians [34].	Engage healthcare professionals and patients in the development process and use real case scenarios [34].	Ensure the cases are reviewed by experts and end-users [34].	Examine current guidelines and literature before developing a case materials.

Steps to writing a case study

John considers the following steps when writing his case study on virtual care model.

1

DEVELOP A GUIDE

The guide will include a summary of the literature, gap analysis, and case examples [34].

2

ORGANIZE A WORKSHOP

Review literature and gap analysis to identify learning outcomes. Members should have a common understanding of the case process [34].

3

PREPARE AND DRAFT CASES

Write cases based on real scenarios that will be relevant to care providers. Keep cases short and use pseudonyms to protect identities [34].

4

REVIEW CASES WITH CONTENT EXPERTS

It is important to review the cases for consistency and adequacy in assessing the learning objectives [34].

Methods for presenting a case



Written case

Written cases include an in-depth description and analysis of the clinical scenario [42].

It provides novel insights to support care providers in optimizing the delivery of care. Cases include details such as assessment findings and test reports [42].



Video case

Video scenarios are filmed based on cases created by subject matter experts [43].

Learners receive the video case study during the CPD session and are also provided with a manual containing the written case, the learning objectives, and relevant information necessary for group discussions [43].



Didactic lecture

A subject matter expert presents the topic and then allows learners to present cases on a voluntary basis [44].

Participants can informally discuss cases that are related to the topic and are engaged in a discussion that can directly impact their practice [44].

Framing the problem and preparation checklist

THINGS TO THINK ABOUT WHEN PREPARING CASE-BASED LEARNING

- Engage stakeholders to help inform case study writing and structure learning objectives.
- Conduct a literature review and gap analysis.
- Organize a workshop to identify priority setting and learning outcomes.
- Prepare and draft short cases relevant to the target audience.
- Pilot test the cases with a cohort of learners.

Case-based learning

3.2.3 IMPLEMENTATION GUIDELINES

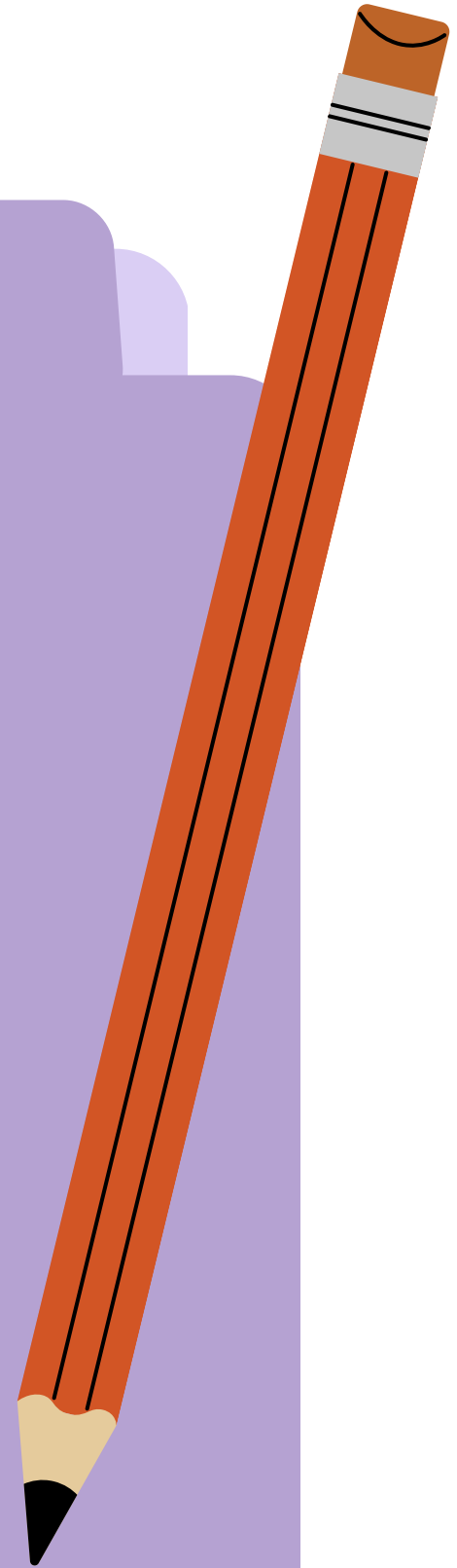
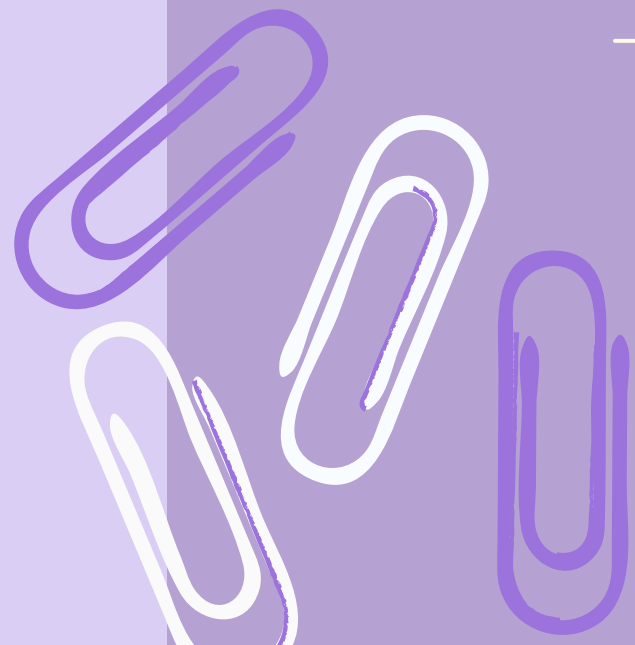

How to facilitate case-based learning

1

Present the case

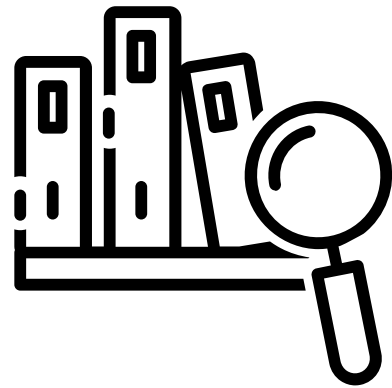

Provide learners with adequate time to read the case.

2

Discuss the case

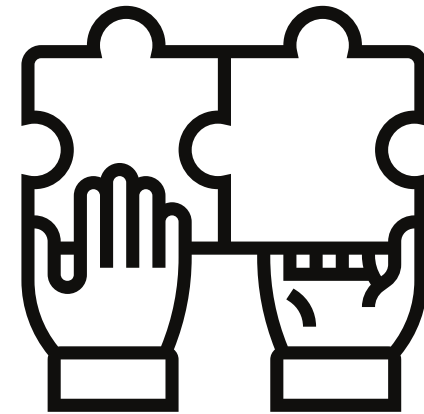

Set goals and identify the problem.
Brainstorm approaches.
Synthesize solutions and reach a consensus.

3

Debrief the case

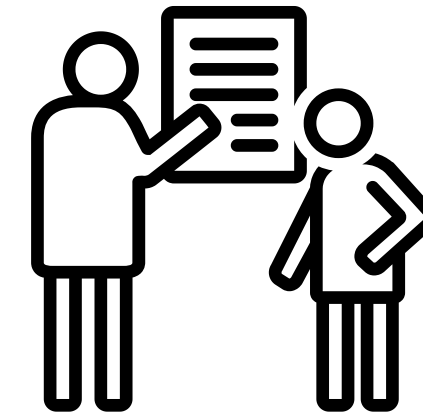

Deliver solutions and engage in knowledge exchange.

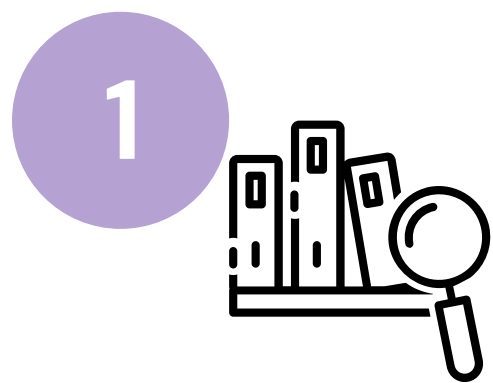

When to present the case

Learner role

Advantages

Disadvantages

Provided **prior** to the CE session and discussed during the CE session

Learners are required to review the case and prepare a solution to the problem identified. During the session, learners work with their peers to come to consensus on a solution [38].

Allows for shorter sessions because learners come to the session prepared with points [38].

Learners come to sessions with solutions rather than working together to come up with a solution [38].

Provided and discussed **during** the CE session

Learners read, analyze and collaboratively propose a solution to the problem identified in the case [44].

Learners work through the case together and can use interdisciplinary perspectives to create a solution [44].

Requires an increased level of learner engagement to direct this process and may require longer sessions to complete the case [44].

Provided **after** the CE session and completed individually

Learners use concepts from the CE session to read, analyze, and complete a case individually [45].

Provides a method to test knowledge uptake during the CE session and learners can work at their own pace [45].

Absence of interdisciplinary perspectives to help analyze the case. Learners will not receive the support of a facilitator [45].

2

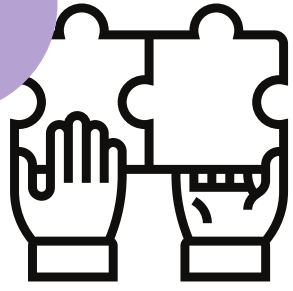

Examine the case through social learning

Cases can be examined through social learning. **Social learning** is a cognitive process, which occurs through the interactions with peers in a social context [46-47]. **Observing the behaviors of others** and **direct reinforcement** are important elements in the transfer of knowledge [46-47]. Role-playing is a valuable strategy to facilitate perspective-taking in solving cases. However, there can be challenges to learner engagement, which could have an impact on the learning process [47].

When developing a case-based learning session to help healthcare professionals adopt virtual care for chronic pain management, John considers strategies for mitigating barriers to learner engagement. The next page explores strategies for how John can develop cases to foster a meaningful learning experience.



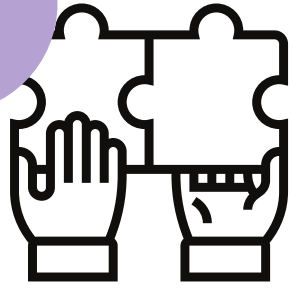

Barriers to learning engagement

1

Environmental distractions

2

Fatigue

3

Minimal attention span

4

Overconfidence or uncertainty

5

Lack of interest and motivation

6

Case considered irrelevant or obtuse by the learner

Mitigation Strategies

Barriers to learning engagement could be addressed:

- Selecting a case that is relevant to your target audience [47]
- Developing cases that provide a unique learning experience and build on existing knowledge [47]
- Establishing trust, which creates a safe space for discussion and critical feedback among peers [40]
- Integrating group activities and providing opportunities for learner interaction [43]
- Utilizing questioning techniques to prompt discussion [20]
- Providing guidance when necessary [20]

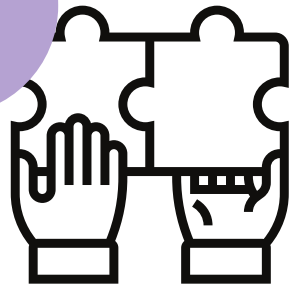

Facilitator's role in case-based learning discussion

Consider
integrating with
Facilitation of
Small Group
Learning
Intervention 1

Create safe environments

- Promote a safe and inclusive environment to encourage and engage learner participation [43].
- Foster an atmosphere in which open exchange of ideas is facilitated [40].
- Outline expectations of respect and inclusion to the group [43].

Support and monitor participants

- Support learners to relate their work on the case to the learning objectives of the course or session [43].
- Attend to the needs of the learner group and aid when needed [43].

Facilitate and moderate discussions

- Provide stimulus to the process by asking leading questions, challenging thinking and raising issues that might need to be considered [43].
- Encourage learners to set the pace of the activity [43].
- Ask questions that are open (and avoid questions that have single correct answers).

Engage learners

- Encourage interactivity through the use of various features in video-conferencing platforms (e.g., chats, polls).
- Ask for feedback from learners to address their learning needs [43].
- Actively listen and validate contributions from group learners [43].

Demonstrate knowledge of topic

- Discuss with learners to ensure they can connect the topic to their broader clinical practice [43].
- Share professional experience to connect the case with practical context [43].

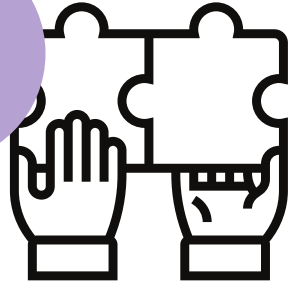

Working through the cases

Intentional environment setup

- The environment sets the stage for collaboration; therefore, the setup should be meaningful to promote discussion [38,44].
- In-Person:
 - Create an open space by moving tables and chairs around in a conference room
- Virtual:
 - Breakout rooms for small discussions
 - Easy to access video conferencing links

Promote collaboration

- Engage learners to perform open inquiry through guiding questions and sharing their varying multidisciplinary expertise [38,44].
- When the learning objectives include team-based or interprofessional competencies, create groups that are representative of diverse disciplines and demographics to help plug knowledge gaps [38,44].

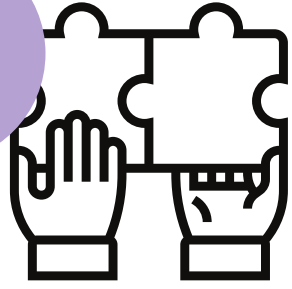

Working through the cases

Learner-directed

- Case-based learning operates most effectively when it is learner-directed and facilitator-monitored [40].
- Encourage learners to:
 - Choose how to approach the case
 - Delegate tasks and roles
 - Use their experiences to inform the case analysis

Check for understanding

- Facilitators play a role in ensuring that learners understand the tasks and topic of the case. If learners have questions, they should first seek answers within their group [40]. However, if the group continues to have difficulty, facilitators can provide some clarification or open-ended questions to guide them [40].
- Ask "Why" or "How" questions to prompt discussion.

3



Questioning in case-based learning

John uses the following questioning framework to prompt discussion in his session.

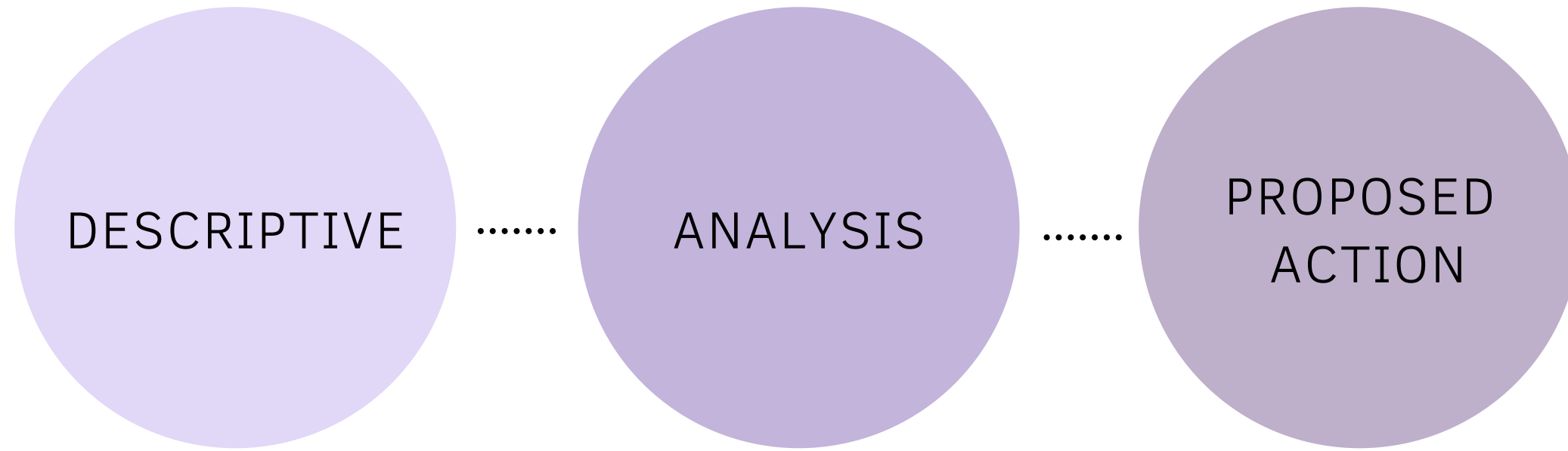

"What"

Help learners dissect what has happened in the case and identify what information is available [45].

"So what"

Detail what is expected of the group and what are different ways they can proceed with the case [45].

"Now what"

Come up with a plan of action based on the details of the case and discussion [45].

3



Dissemination of case analysis

The outcomes of case analysis can be varied and will be dependent on the curriculum.

John can consider the following examples to engage learners in synthesizing their case results.

Written report

Learners:

- Submit the report during or after the session [42].

Facilitator:

- Explains the solution and how it relates to the curriculum [42].
- Outlines the process of case analysis [42].

Formal presentation

Learners:

- Create a slide deck to present the solution [43].

Facilitator:

- Highlights the steps taken to analyze the case and connect it to the curriculum [30].
- Interacts with session participants by asking for feedback and for any questions they might have [43].

Informal open-discussion

Learners:

- Build on each other's ideas to explain possible solutions and address challenges [44].

Facilitator:

- Collectively discusses with larger group the process the smaller groups took to approach the case [44].

Online discussion board

Learners:

- Post their solutions to an online discussion board and openly comment on their peers' solutions [37].
- Peers provide feedback and critique post-session [37].



How to debrief the case

Consider
integrating with
Reflective
Learning
Intervention 3

Debriefing is a direct and intentional conversation among the learner group to summarize the session and come to conclusions about the case [37]. It usually takes place after the group has worked through the case and has synthesized the results [37]. John uses the following steps to engage the learners in debriefing the case during his CE session:

- Prompt** learners with questions to get them to reflect on the key takeaways from the case [48].
- Give individual learners or groups an appropriate amount of time to **generate** their responses and **record** answers either on paper or through an electronic poll [48].
- Share** ideas or thoughts about the case between groups or in pairs [48].
- Engage each pair or group to share their responses with the **larger group** and participate in an in-depth discussion [48].
- The **facilitator shares** their own key takeaways and **relates** them to the points raised by the learners. At this point, the facilitator **fills any gaps** and **clarifies** concepts covered in the case [48].

Implementation checklist

THINGS TO THINK ABOUT WHEN DELIVERING CASE-BASED LEARNING

- Consider when to present the case to learners (before, during, or after the session).
- Foster an inclusive and safe learning atmosphere.
- Maximize the transfer of learning by creating a collaborative learning space.
- Incorporate questioning strategies as part of the instructional design to encourage critical thinking and fruitful discussion.
- Select the best approach to disseminate the case analysis and debrief.

Case-based learning

3.2.4 KEY CONSIDERATIONS

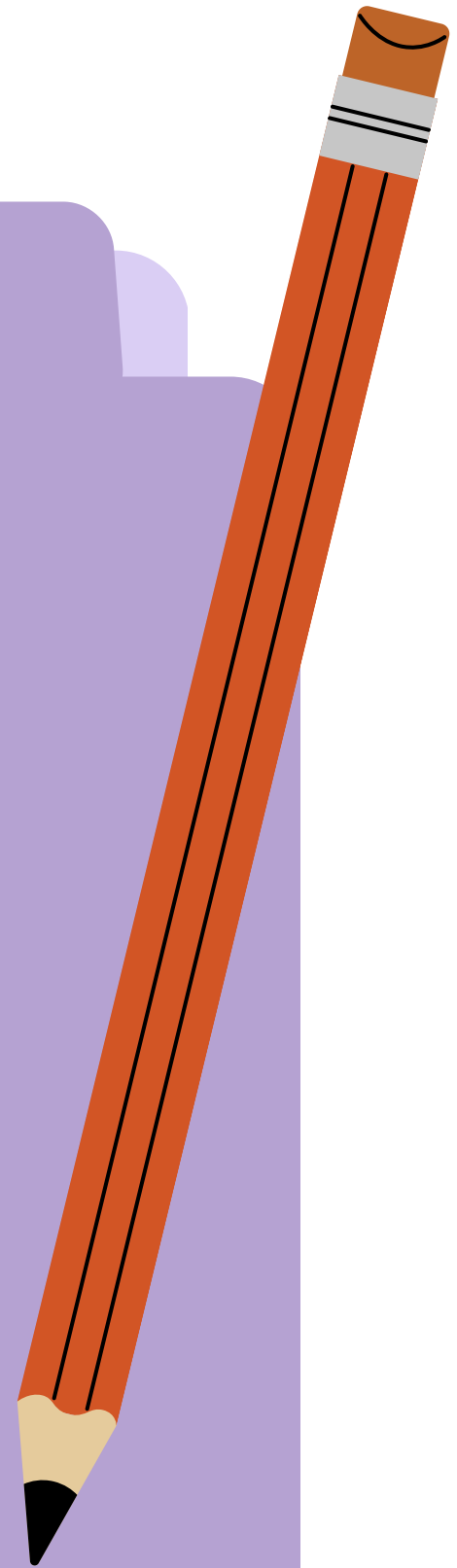
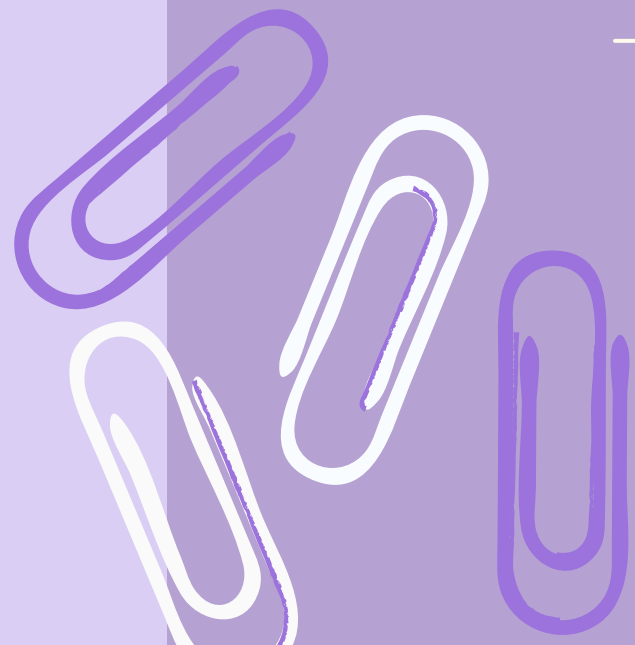

Group learning **delivery methods**

Here are some considerations when selecting the delivery methods:

	Small group delivery	Large group delivery	Virtual/blended delivery
Description	<ul style="list-style-type: none">• From four to eight participants work on completing the case [49].	<ul style="list-style-type: none">• Groups larger than 20 learners work on analyzing a case. The session usually integrates a didactic lecture to complement discussion [44].	<ul style="list-style-type: none">• The use of video conferencing platforms to conduct case-based discussions and activities [50].
Facilitator role	<ul style="list-style-type: none">• Help guide and monitor discussion [49].• Only assist when the group requires help or asks for help [49].• Provide feedback to the group and ask open-ended questions to prompt discussion [49].	<ul style="list-style-type: none">• Present case to the group [44].• Active role in facilitating and leading discussion [44].	<ul style="list-style-type: none">• Mitigate technology difficulties [50].• Create discussion groups/breakout rooms [50].• Manage learner discussion and encourage participation from all learners [50].• Inform participants of video conferencing tools that can be used [50].
Learner role	<ul style="list-style-type: none">• Engage in active participation [49].• Create self-directed plan on how to approach case [49].• Be attentive and respectful of group's ideas [49].	<ul style="list-style-type: none">• Actively participate and contribute to the case discussion [44].• Integrate simple large group collaborative approaches such as think-pair-share.	<ul style="list-style-type: none">• Leverage tools on video conferencing platforms to participate [50].• Actively join the discussion with the camera on or participate through the chat box function [50].

Challenges: Delivery approaches

In-person

- Unequal or lack of participation can affect case analysis and group discussion [49].
- A facilitator who too actively participates takes away important decision-making opportunities from learners [49].
 - **Mitigation:** The facilitator stays within the role and only monitors.
- Physical Setting: availability of an open and movable setting may not always be an option, which could detract from a case discussion and analysis [49].

01

Virtual or blended

- Access to technology
- Lack of digital literacy
- Challenge in monitoring virtual learner progress [49].
- Difficulty monitoring active participation and learner engagement if the camera is off [49].
 - **Mitigation:** Set expectations at the beginning of the session; reinforce throughout the session.
- The malfunctioning microphone may limit participation [49].
 - **Mitigation:** Encourage the use of the chat box if the microphone is not working.

02

Sample: Planning canvas

KEY CONSIDERATIONS

Who would you engage to develop the case?

When would you present the case?

How would you work through the case?

How would you present the case (before, during or after the session)?

What delivery approach would you select?

How would you debrief the case?

Consider how you will **evaluate** your CE session

Evaluation is an essential component of a CE session to assess knowledge uptake, identify how learners interacted with the activities, and examine whether learning objectives were effectively translated into practice. It provides an opportunity for both the facilitator as well as the learner to reflect on the session and provide constructive feedback to each other. Check out [Section Four](#) on page [155](#), which provides detailed strategies on how to assess and evaluate your CE interventions.

Consider the following questions when evaluating and assessing a CE session:

- ✓ How can I assess and evaluate the outcomes of a CE intervention by [engaging stakeholders](#)?
- ✓ What frameworks can be used to inform my evaluation questions and process ([RE-AIM](#), [Kirkpatrick-Barr](#), [Moore's framework](#))?
- ✓ What are some evaluation approaches I can integrate into my CE session ([knowledge tests](#), [semi-structured interviews](#), [feedback surveys](#))?
- ✓ How can I provide and utilize [feedback](#) to improve the CE session?

Additional resources

Further reading



- McLean SF. Case-Based Learning and its Application in Medical and Health-Care Fields: A Review of Worldwide Literature. *J Med Educ Curric Dev.* 2016;3. doi:[10.4137/JMECD.S20377](https://doi.org/10.4137/JMECD.S20377)
- Leung JS, Brar M, Eltorki M, Middleton K, Patel L, Doyle M, et al. Development of an in situ simulation-based continuing professional development curriculum in pediatric emergency medicine. *Advances in Simulation.* 2020;5(1):12. doi:[10.1186/s41077-020-00129-x](https://doi.org/10.1186/s41077-020-00129-x)

3.3 Reflective learning

INTERVENTION THREE

Reflective learning: a type of learning where learners critically reflect upon their own thoughts, behaviors and actions in practice scenarios [51-52].



Intervention 3

In this subsection:

Introduction to reflective learning

- Why reflective learning?
- Case scenario
- Guiding questions
- Key enablers
- Formula for success

Framing the problem and preparation

- Determine learning goals for reflective learning
- When to use reflective learning
- Importance of facilitator's role
- Brave space for learning

Implementation guidelines

- Stages of critical reflective inquiry model
- Applications of the critical reflective inquiry model
- Question prompts for reflective learning

Key considerations

- Key principles for facilitation of reflective learning
- Considerations for facilitating reflective learning
- Challenges
- Using reflective practice within a virtual context

3.3.1 Introduction to reflective learning



The previous modules provided you with the necessary guidelines and tools to implement small group and case-based learning sessions. This module will prepare you to implement reflective learning in a CE session. Note that reflective learning can be integrated as a component within small group or case-based learning sessions.

Key Terms:

Brave Space: enable a safe learning environment, where learners engage authentically with their peers in challenging discourses [53-54].

Critical Reflective Inquiry (CRI): this model enables care providers to learn from their experiences and evaluate by exploring the knowledge, beliefs, and attitudes ingrained in clinical practice settings [51].

Why facilitate reflective learning?

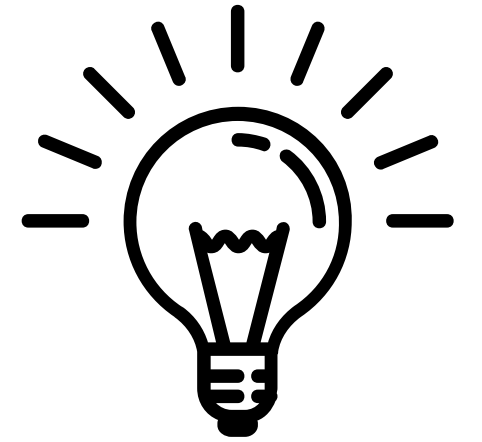

In a rapidly evolving healthcare system with continued importance on lifelong learning, it is critical for clinicians to **continuously update** their knowledge and reflect on their clinical practice [56]. Reflective learning provides an opportunity for healthcare practitioners to deliberately think about their clinical environment; subsequently, this educational intervention plays an influential role in **promoting practice change** [55]. Reflection encourages healthcare practitioners to examine their daily actions and the nature of their work routines, which is imperative in ensuring the **quality of healthcare provision**. Reflective learning offers a pragmatic avenue to advance CE practices [52].

Case scenario

Due to the COVID-19 pandemic, there has been an increased burden on the healthcare system and a rapid shift in clinician workload. At a hospital, there has been a shortage of staff and high turnover. The staff are very stressed with all of the required work and are reporting high levels of burnout. Aliyah, an education coordinator, has been tasked with creating a CE program to promote wellness and principles of resilience among clinicians. The planning committee is considering incorporating ways to reflect on practice to encourage self-awareness and a commitment to lifelong learning.

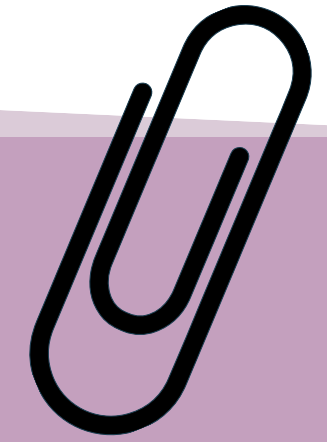

5.1.2 As Aliyah is developing a reflective learning session, she considers the following:

1	Why should I consider adding reflection into the learning plan?
2	How would I integrate reflective learning into the CE session to promote the wellbeing of clinicians?
3	How would I ensure a safe and inclusive learning environment for discussion?
4	How would I encourage learners to participate in reflective learning?
5	How would I integrate reflective learning within a virtual context?
6	How do I assess reflections, follow-up and give feedback to ensure the integrity of the activity?

Key enablers

INTERVENTION INTRODUCTION



Identify learning needs and practice gaps

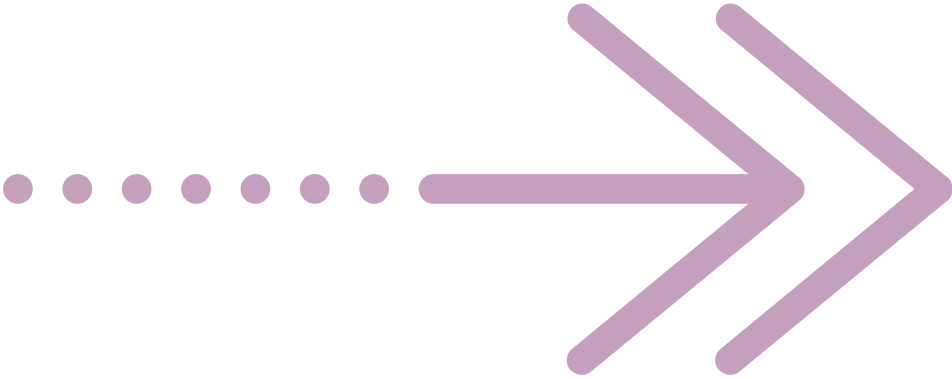

Create a supportive and continuous learning process

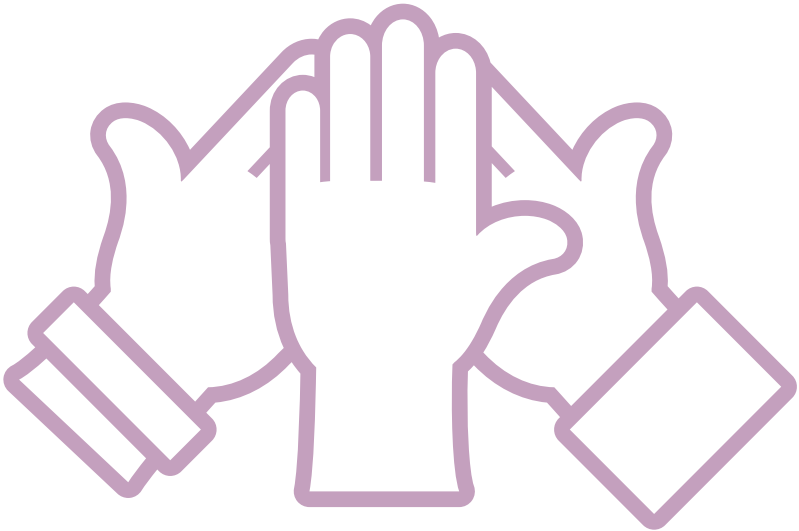

Establish a brave space for learning

Identify learning needs and practice gaps

It is critical to identify learning needs and practice gaps as reflection is based on reconceptualization of past experiences that lead to further reflection and inform new experiences [57].

Using a structured approach helps to transform the practice experiences of care providers into tacit—rather than only explicit—knowledge. This leads to increased self-awareness and identification of gaps in knowledge and skills, thereby improving practice change and patient care delivery [51].



Supportive and continuous learning process

Reflective learning is a process rather than a single-time event. To do this well, facilitators should act as guides to learners, supporting them through the process of reflection [57-59].

Framing and reframing, open dialogue, and helpful feedback encourage learners (and facilitators) to identify gaps, reflect on new material, situate it into their own personal contexts, and encourage continual learning and practice change [57-59].

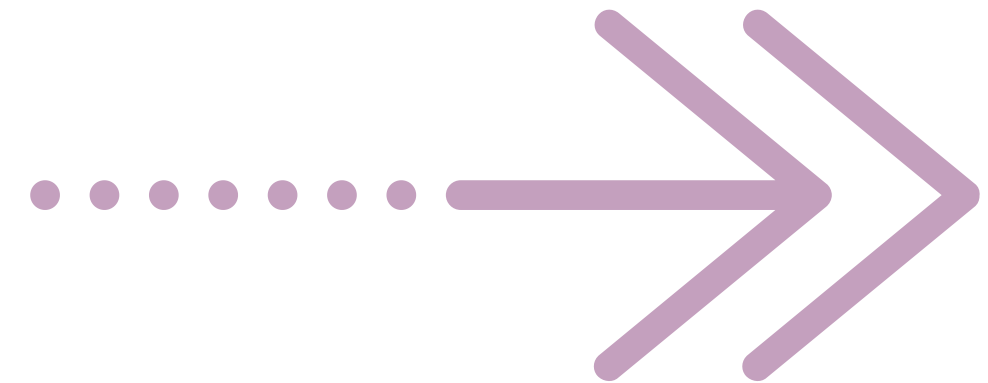

Create a brave space for learning

Brave spaces enable a safe learning environment, where learners engage authentically with their peers in challenging discourses [53-54]. Although brave spaces can create discomfort for learners, they provide resources and support to those who are most sensitive and facilitate a deep and extensive conversation [53-54]. Support is intended to enhance and not draw away from participation and learning opportunities [53-54].

The best reflections come from being in a position of discomfort; thus, educators who wish to stimulate more meaningful reflections need to be willing to be provocative, sometimes profoundly so. Thus, they need to create not only safe spaces, but brave spaces.

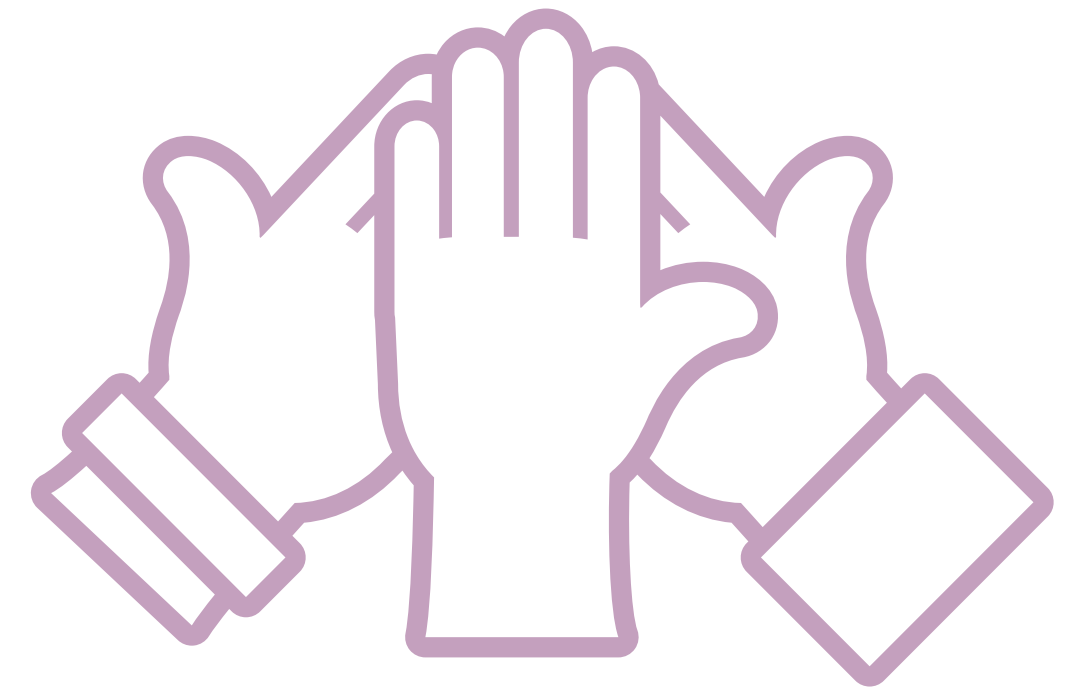

Formula for success

1

Develop contextual and situated reflective learning activities.

2

Facilitate with clear guidance and practical goals, ensuring continuous integration into context.

3

Evaluate with the learner's end goals in mind, providing feedback in a safe and productive way to help identify gaps and integrate new knowledge into practice.

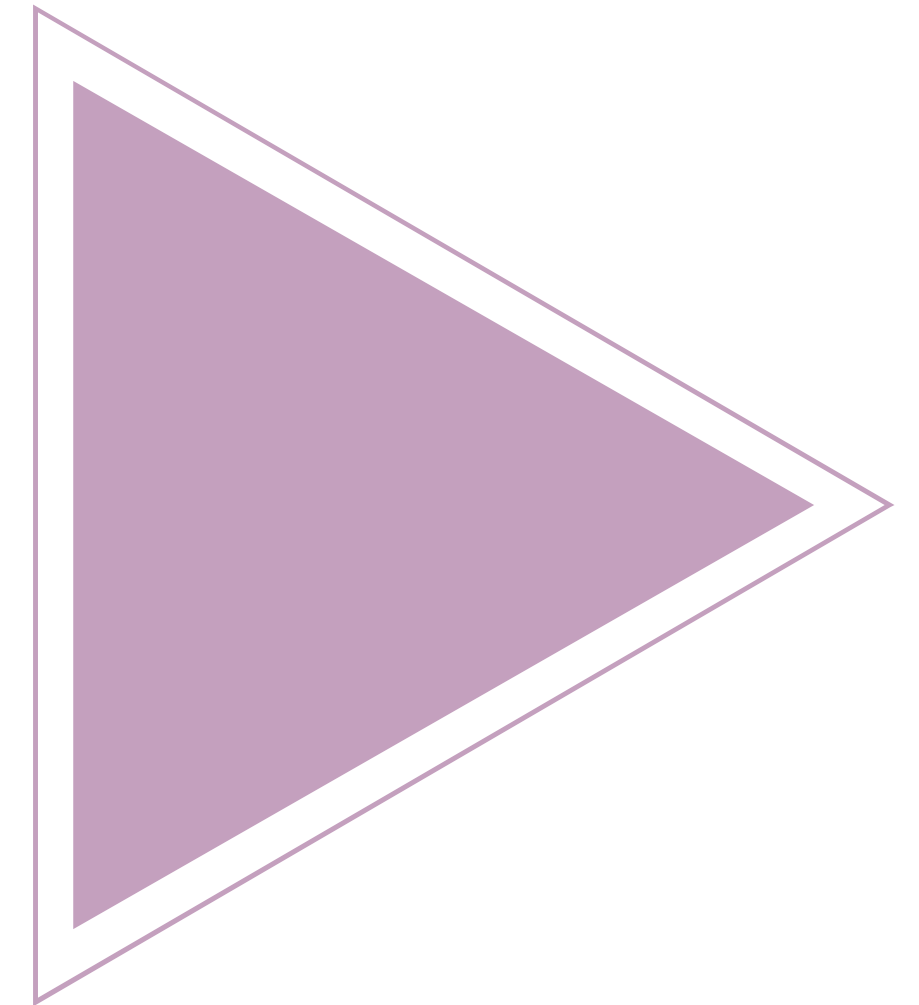

Reflective learning

3.3.2 FRAMING THE PROBLEM AND PREPARATION

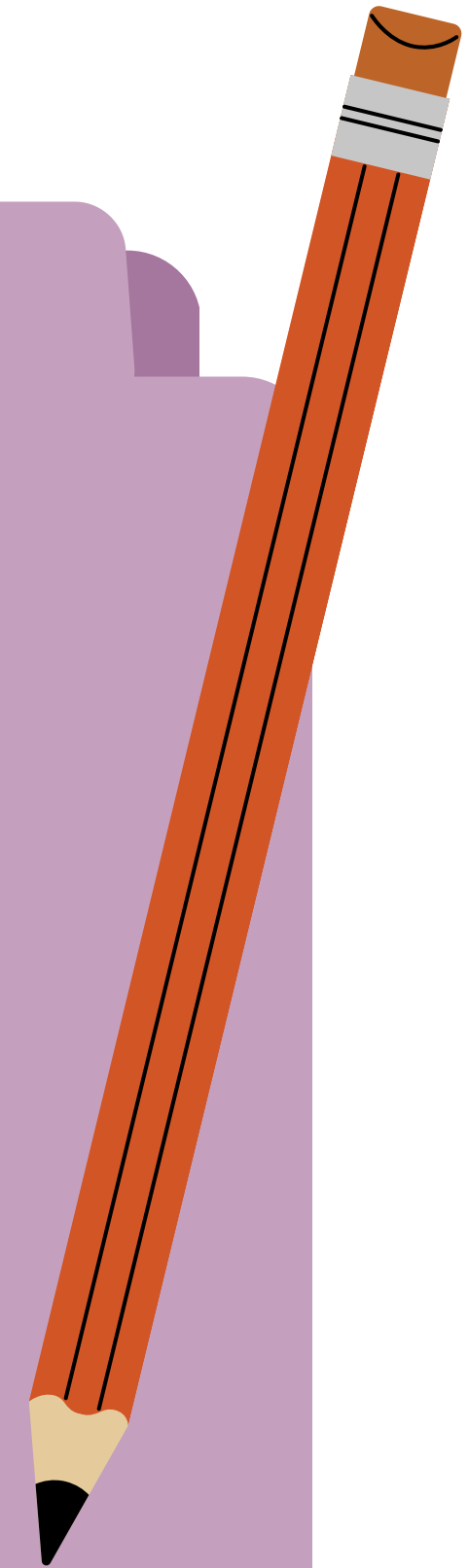
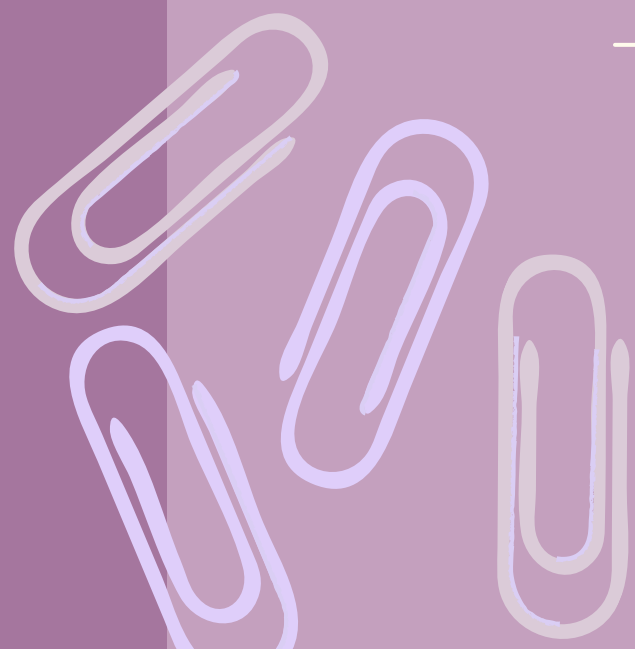

Determine learning goals for reflective learning

When determining learning goals, CE leaders or educators should consider the following guiding questions:



Are there any gaps in **knowledge, skills, and attitudes** that should be addressed [57]?







How can reflective learning be used to help **integrate** care providers' new learning with existing knowledge and past experiences and incorporate it into current or future practice [57]?

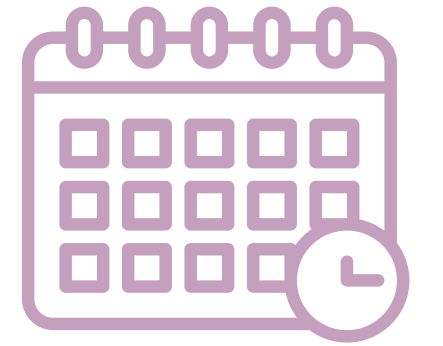

Is the aim of reflective learning to identify practice needs or focus on learning [57]?

When to use reflective learning



-  Reflection can take place at any point of an event or situation: before, during and after [59].
-  Reflection prior to an encounter can contribute to self-development and lifelong learning. This allows learners to challenge their perceptions or approach a situation with a specific learning objective [59].
-  Reflective learning can be integrated within a larger CE intervention to maximize the learning experience [57].

Importance of facilitator's role in reflective learning

Consider
integrating with
Facilitation of
Small Group
Learning
Intervention 1

HOW TO PREPARE

01

Promote Deeper Reflection

Encourage learners to consider their scenario beyond what was initially presented. This level of self-awareness will enable learners to understand how they can make positive changes to practice [52,55,60].

02

Create Brave Spaces

The presence of a brave space in place of a safe space encourages a positive view of critical reflection. This can shift learner mindset in seeing reflection as a necessary part of small-group learning [53-54].

03

Facilitate Discussion

Learners can present their narratives to analyze in a small group using the critical reflective inquiry model [51]. Learners can act as peer facilitators in reflective analysis and discussion.

What is brave space

BRAVE SPACE

- Brave spaces are necessary for creating reflective learning since the learning stimulus can be necessarily provocative. Brave spaces can be established through creating **classroom guidelines** and **etiquette** [61].
- An emphasis is placed on **social justice**, thereby creating a space that is equitable and inclusive of all social identity groups [61].
- Key principles that promote brave space include controversy with civility, owning intentions and impact, challenge by choice, and respect [61].

ENGAGE
LEARNERS

1

Engage the learners in co-creating ground rules or amending existing rules [61].

OPEN
DIALOGUE

2

Facilitate an open dialogue by sharing diverse viewpoints respectfully [61].

CREATE A
SPACE

3

Provide an equitable and inclusive space to share stories and thoughts [61].

Create a brave space for learning

HOW TO PREPARE



CONTROVERSY WITH CIVILITY

Different views are encouraged. Learners work to understand the cause for conflicting perspectives and collaboratively work together to identify a common solution [53-54].



OWNING INTENTIONS AND IMPACT

Facilitators foster a safe learning environment that encourages learners to engage with less fear and greater honesty [53-54].



CHALLENGE BY CHOICE

Learners have the choice to determine the activities in which they would like to engage. During a challenging conversation, facilitators can probe learners to stimulate discussion [53-54].



RESPECT

It is imperative to show respect to one another and understand the various cultural values and beliefs individuals bring with them [53-54].

Framing the problem and preparation checklist

THINGS TO THINK ABOUT WHEN PREPARING REFLECTIVE LEARNING

- Determine learning goals for reflective learning.
- Determine when to integrate reflective learning with your CE intervention.
- Plan the stimulus that will activate the learners, create engagement and generate reflective thinking.
- Create a brave space for learning.
- Plan for how to record and retain the reflection(s) from each learner.
- Plan for how to use the recorded reflections to facilitate and encourage behavior or practice change.

Reflective learning

3.3.3 IMPLEMENTATION GUIDELINES

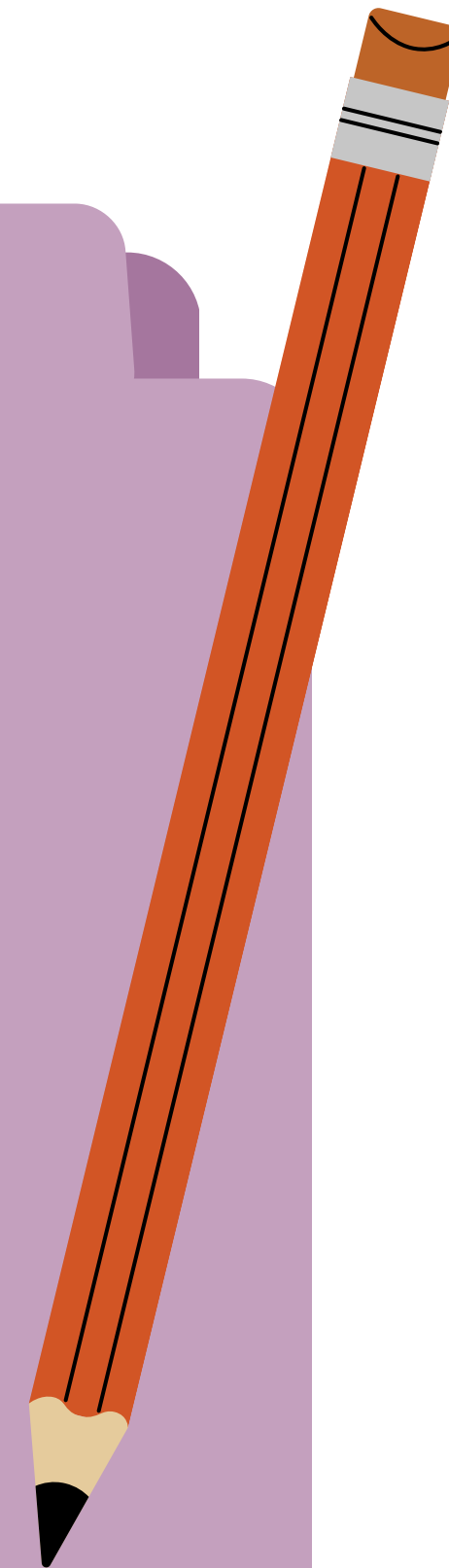
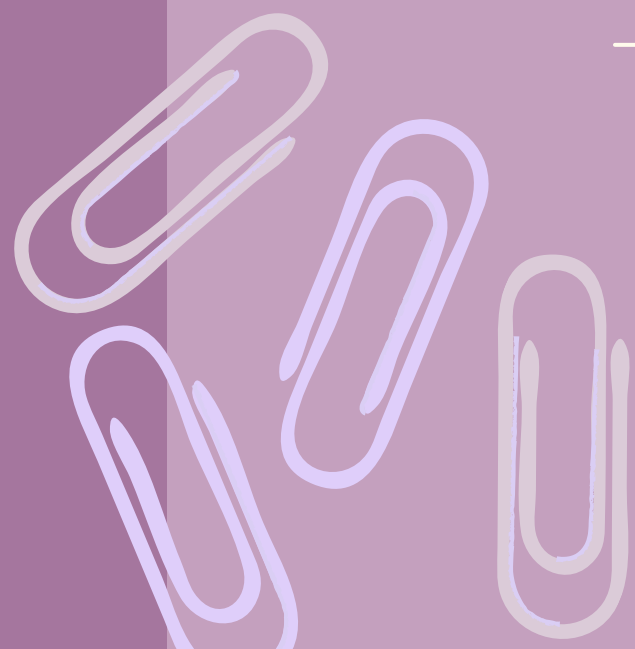

Stages of critical reflective inquiry model (CRI)

Use the CRI model to facilitate reflective learning [51].

DESCRIPTIVE

- Consider whether to ask learners to draft a written narrative of a practical situation they wish to analyze using reflection [51].
- These narratives should include all characteristics of the scenario, including how the learner felt, thought and acted [51].

REFLECTIVE

- Assist learners in examining their narratives using reflective analysis to compare their feelings, thoughts and behaviors to [51]:
 - scientific knowledge/ethical standards
 - their own intentions
- This process will facilitate self-awareness among learners on how they deliver care and how they can improve their own practices [51].

CRITICAL

- Encourage learners to critique their own practices to remove inefficiencies and incorporate new developments where necessary [51].
- Facilitate dialogue for learners to examine disparities between their own [51]:
 - beliefs vs practice, intentions vs actions, patient needs vs learner actions.

Applications of the critical reflective inquiry model



Knowledge creation: Reflective analysis of narratives can add to current best practices and applications of knowledge to practice. It can be used to guide learners' own practice [51].



Improving practice: Encourages continuing professional development of learners [51].



Knowledge transfer: This model can be used in group settings such as conferences to analyze and discuss practice scenarios. Learnings can be applied to individual practice [51].



Personal action plan: Action plans can be created by learners to help them reach their goals.

Implementation checklist

THINGS TO THINK ABOUT WHEN USING REFLECTIVE LEARNING

- Encourage learners to create a plan of action based on their practice situation.
- Encourage learners to compare their situation to standard practices.
- Support peer facilitation and creation of brave spaces for dialogue.

HOW TO IMPLEMENT

Reflective learning

3.3.4 KEY CONSIDERATIONS

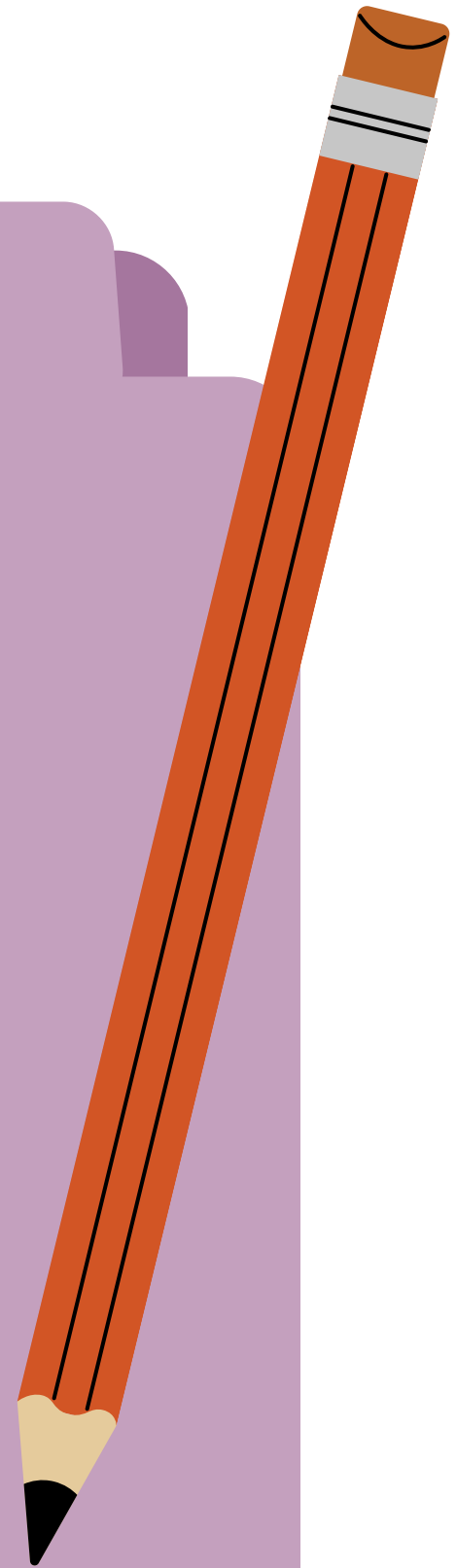
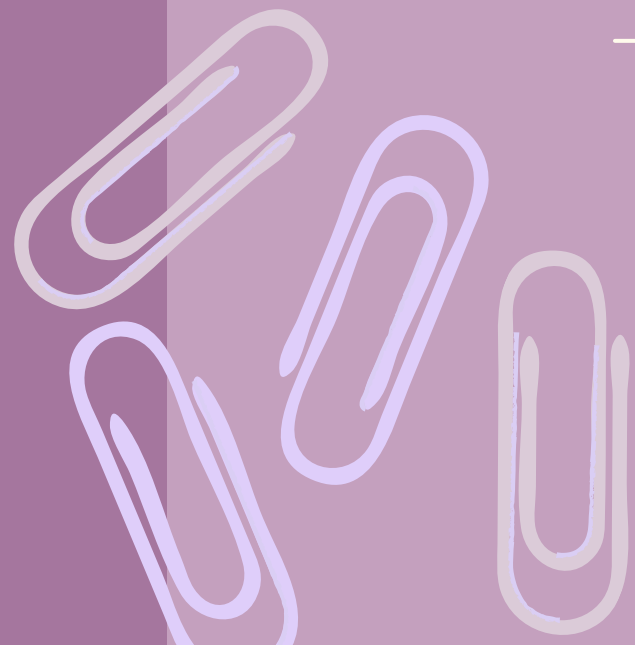

Key principles for facilitation of reflective learning

KEY CONSIDERATIONS

1

Clear guidance

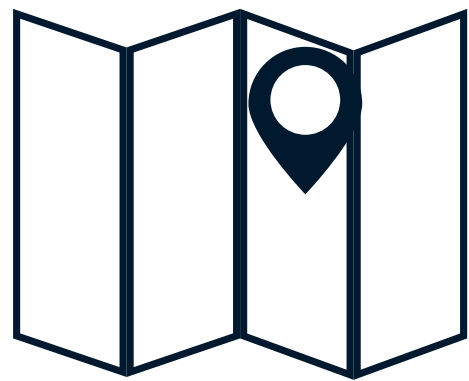

Provide learners with clear guidance on critical reflection [57].

2

Practical goals

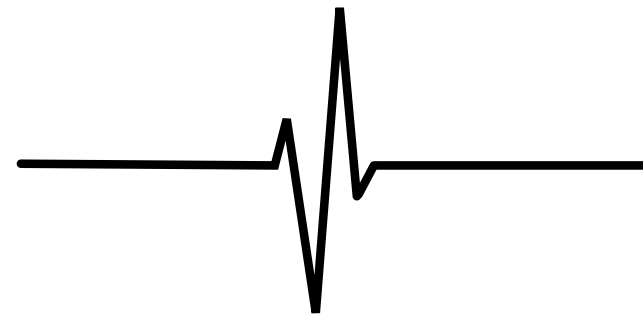

Frame reflection as a practical goal (e.g., enhancement of patient care) [62].

3

Integration

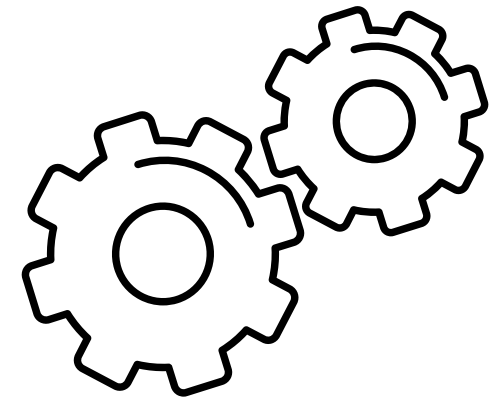

Integrate reflective learning into existing curricula and design of competency-based assessments [63].

Considerations for facilitating reflective learning



✓ Identify learning needs

Identifying learning needs based on a critical reflection of one's experience and practice is vital [64]. Focus on integrating new learning with existing knowledge and stimulating cognitive experience [57].



✓ Understand values

It is critical for practitioners to understand their personal beliefs, attitudes, and values. Reflection provides an explicit approach to their integration [64].

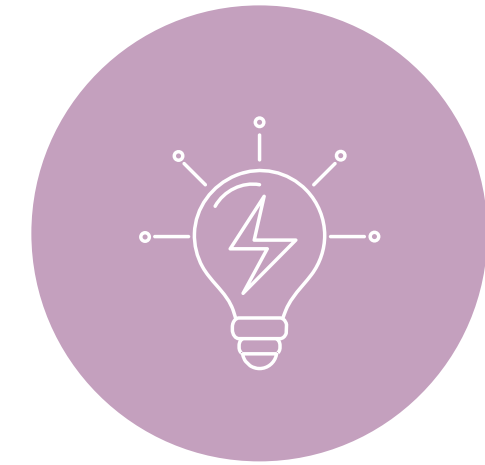

✓ Active learning

An active approach to learning is important for creating an integrated knowledge base that leads to the consolidation of new and existing knowledge [64].

Challenges with reflective learning

LACK OF TIME

Acquiring time away from clinical practice can pose a challenge to participation in reflective learning sessions. Additionally, time to complete reflection exercises and portfolios may potentially hinder participants from actively participating [51,56,64].

MINIMAL ENGAGEMENT

Learners may be guarded and reluctant to be transparent when asked to share their gaps in knowledge and/or deficiency in skills. Reflective learning was perceived to decline among clinicians who have been practicing for several years [59].

DIFFICULTY WITH ASSESSMENT

Assessing reflective learning is challenging due to the absence of validated tools, insufficient resources, and the uncertainty of the learning objectives. In addition, assessment length can contribute to fatigue and learners may not be honest during reflective activities [56].

Using reflective practice within a virtual learning context

Aliyah considers the following examples for delivering the CE session virtually:

Digital storytelling

1. Learners take photographs to express emotions before, during, and after a clinical scenario [59].
2. Learners reflect on experiences [59]:
 - a. How they dealt with the situation.
 - b. What they would do differently next time.
3. Learners present their digital story (e.g., MS Powerpoint/MS Photostory) [59].
4. Learners can also create an ePortfolio with a collection of stories [59].

01

Virtual expert panel

1. Activity is presented with an image and guiding questions [65].
2. Chat functionality can be used to facilitate and engage in discussions with panelists [65].
3. In this way, participants can reflect on diverse perspectives of the same situation [65].

02

Sample: Reflective practice

Topic you are reflecting on:

How would you describe this event (describe your feelings)?

1 What happened

Question 1: Provide a brief description of the situation. How did you respond? How did you feel during and after the event?

2 Looking back

Question 2: Do you think you have achieved your learning goals? Why or why not? Are you satisfied with how you handled the situation?

3 Looking forward

Question 3: What lessons did you learn from this scenario? What is one thing you want to remember or change from this activity? What do you plan to do differently now?

Sample: Personal action plan

1. What changes do you want to make as a result of attending this CE session? Aim to define at least two specific and measurable changes.

2. How important is it for you to achieve your stated learning objectives for this session on a scale from 1-5? (1=least important, 5=most important)

1 2 3 4 5

3. How confident are you that you can achieve your goal(s) on a scale from 1-5 (1=least confident, 5=most confident)

1 2 3 4 5

4. Define a timeline for your strategy. When do you plan to start, assess, and finish the process?

Start Date:

Assess Date:

Finish Date:

5. How will you know that you have reached your goal? What and how will you measure it?

6. What barriers will you encounter? What strategies could you employ to address them?

7. What resources do you have or need to achieve your goal?

Consider how you will **evaluate** your CE session

Evaluation is an essential component of a CE session to assess knowledge uptake, identify how learners interacted with the activities, and examine whether learning objectives were effectively translated into practice. It provides an opportunity for both the facilitator as well as the learner to reflect on the session and provide constructive feedback to each other. Check out [Section Four](#) on page [155](#), which provides detailed strategies on how to assess and evaluate your CE interventions.

Consider the following questions when evaluating and assessing a CME/CPD session include:

- ☑ How can I assess and evaluate the outcomes of a CE intervention by [engaging stakeholders](#)?
- ☑ What frameworks can be used to inform my evaluation questions and process ([RE-AIM](#), [Kirkpatrick-Barr](#), [Moore's framework](#))?
- ☑ What are some evaluation approaches I can integrate into my CE session ([knowledge tests](#), [semi-structured interviews](#), [feedback surveys](#))?
- ☑ How can I provide and utilize [feedback](#) to improve the CE session?

Additional resources

Further reading



- NHS Training for AHP Support Workers: [Workbook 10: Reflective Practice and Continuing Professional Development \(CPD\) Portfolios](#)
 - Workbook that outlines how health care professionals can engage in reflective practice and continuing professional development
- Royal College of Radiologists: [Reflective learning template](#)
 - Template for personal reflection on CPD activities
- Health and Care Professions Council: [Reflective practice template](#)
 - Template outlining prompts to engage individual learners or groups in reflection

Quick guide to assessing and evaluating CE interventions

SECTION FOUR

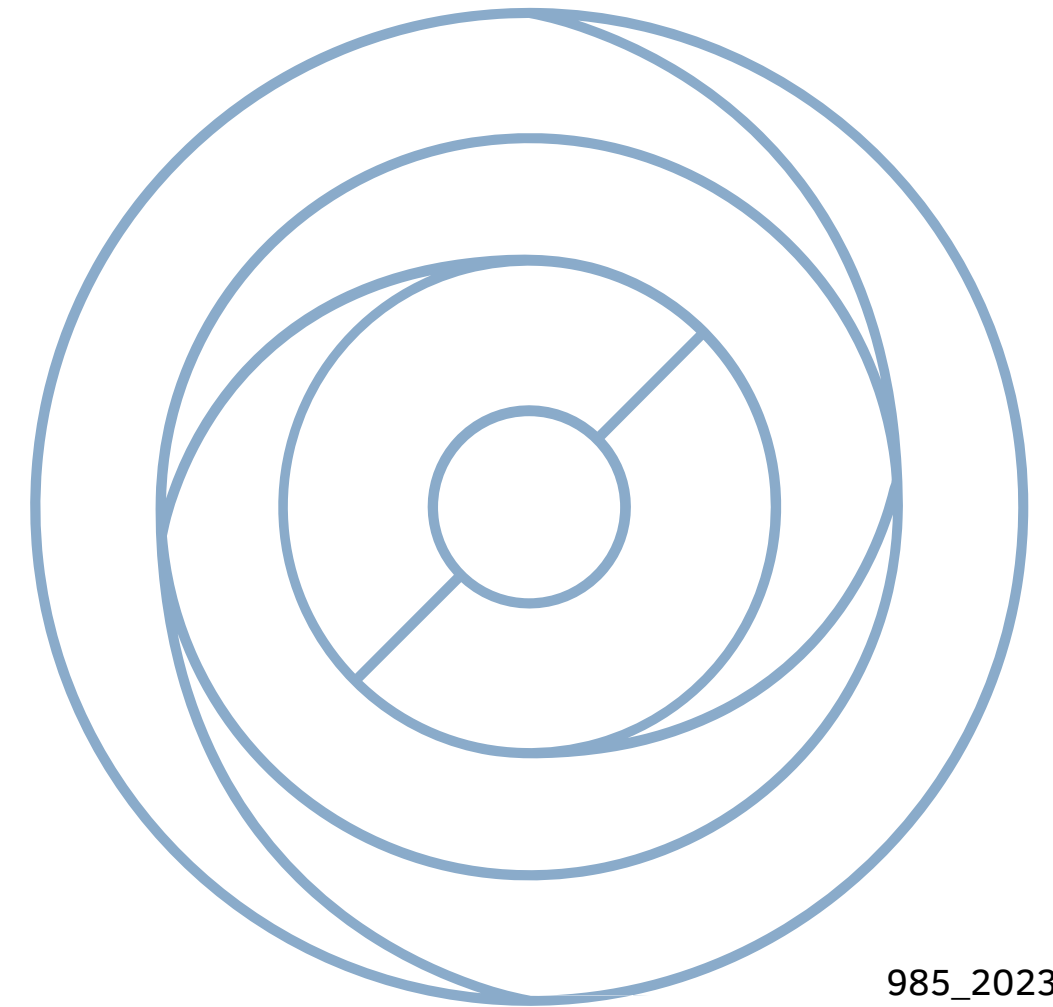

Section 4

In this section:

4.1 Assessing knowledge comprehension

- Knowledge comprehension assessment

4.2 Session feedback

- Providing feedback on the CE session

4.3 How to evaluate the intervention

- Identify key stakeholders
- Logic model
- Outcome frameworks for evaluation
- Evaluation approaches

Assessment, feedback, and evaluation

Continuous evaluation is important in understanding the efficacy of educational interventions and determining whether the learning has been translated into practice.

The evaluation aims to improve the longitudinal and sustainable adoption and implementation of evidence-based CE interventions for healthcare professionals [7].



01

KNOWLEDGE COMPREHENSION



02

SESSION FEEDBACK



03

EVALUATION OF INTERVENTION

4.1 Assessing knowledge comprehension of learners

Purpose

Goals of CE interventions include assessing learners' problem-solving, decision-making skills, and knowledge uptake. However, knowledge comprehension assessments can be used to identify the extent of **knowledge uptake** within the group [66].

Although comprehension assessments are not mandatory, they can serve as a form of reflection and allow learners to set benchmark goals in areas they want to work on more [66].

Goals

- 1** Assess the learner's knowledge and/or attitude retention. Requires post-session assessment [66].
- 2** Assess the change in the learner's knowledge and/or attitude. Requires a pre- and post-session assessment [66].

Modality

Knowledge, skill, and attitude assessments are largely performed using **multiple-choice questions and case-based vignettes** in the form of tests or surveys. Questions should be short and framed around the learning outcomes of the session [66].

Knowledge comprehension assessments, while helpful, are not a measure of actual or anticipated practice performance [66].

4.2 Providing feedback on the session

Provision of feedback promotes learning by informing learners of their progress, highlighting areas of improvement, and providing learners with an opportunity to evaluate their own performance [27]. It also assists in self-reflective practices for facilitators to identify areas to improve on and strategies that worked well with the learners [27]. The following diagram outlines the Pendleton feedback model to engage learners in providing instant facilitator feedback [27].

HOW TO EVALUATE

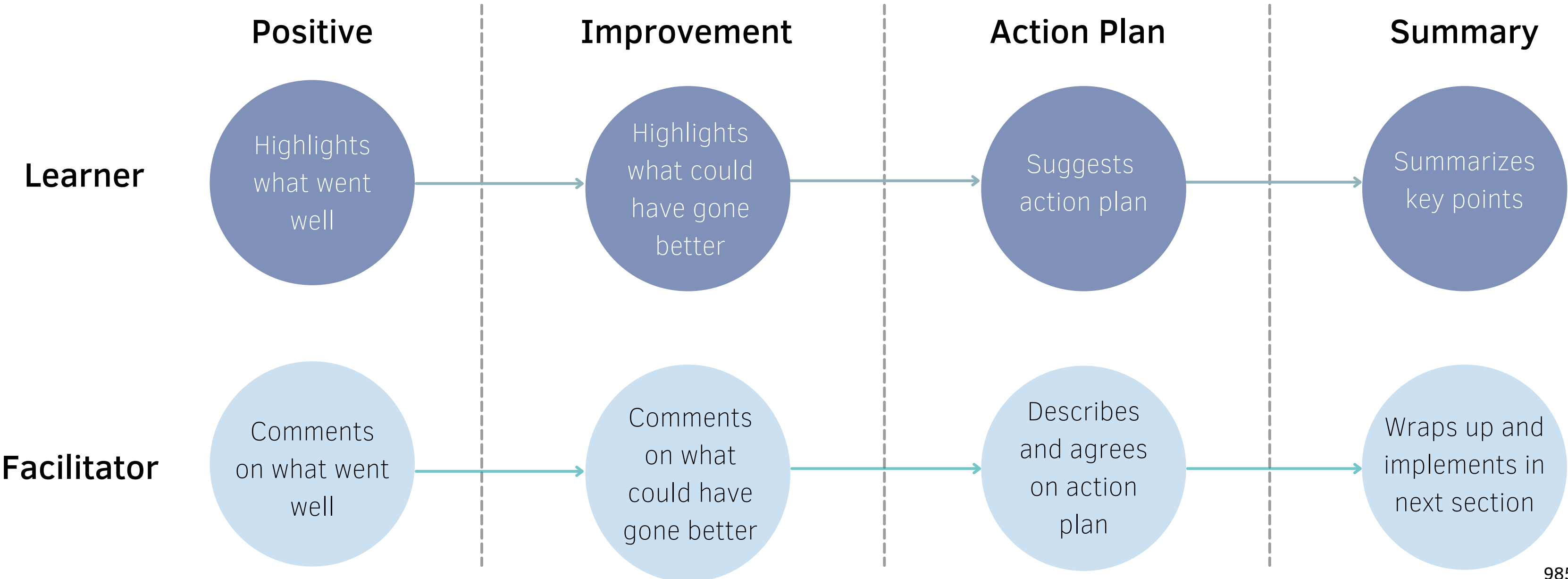

4.3 How to evaluate the intervention

Evaluation is important in ensuring your intervention meets the intended goals and whether it was implemented as intended. This section will provide you with the tools to appropriately and effectively evaluate CE education interventions. Below is a three-step process to help guide you through the evaluation and identify potential opportunities for improvement.

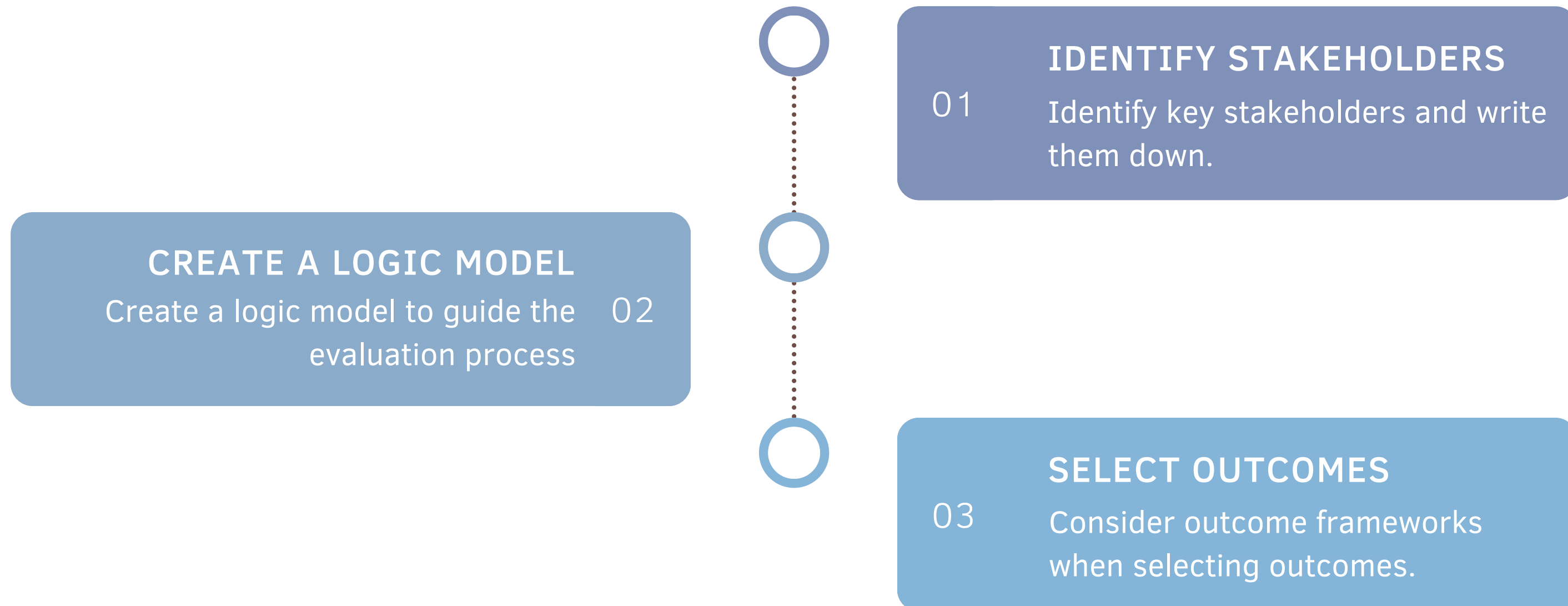

1 Identify key stakeholders

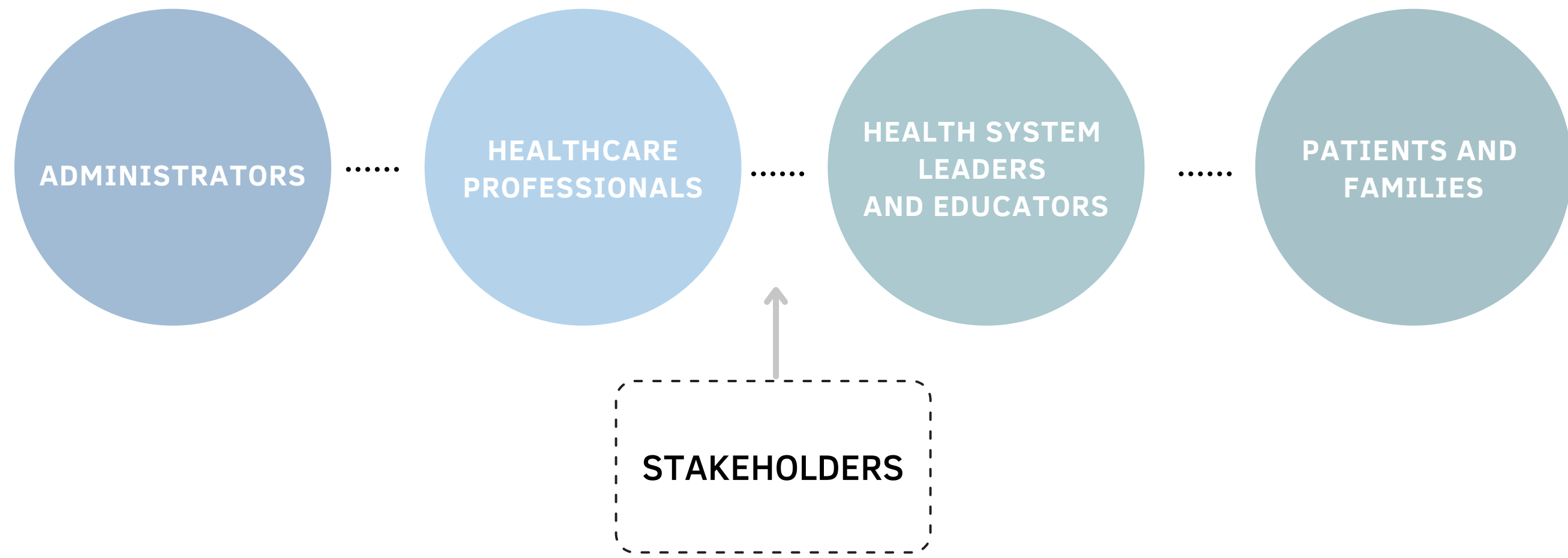
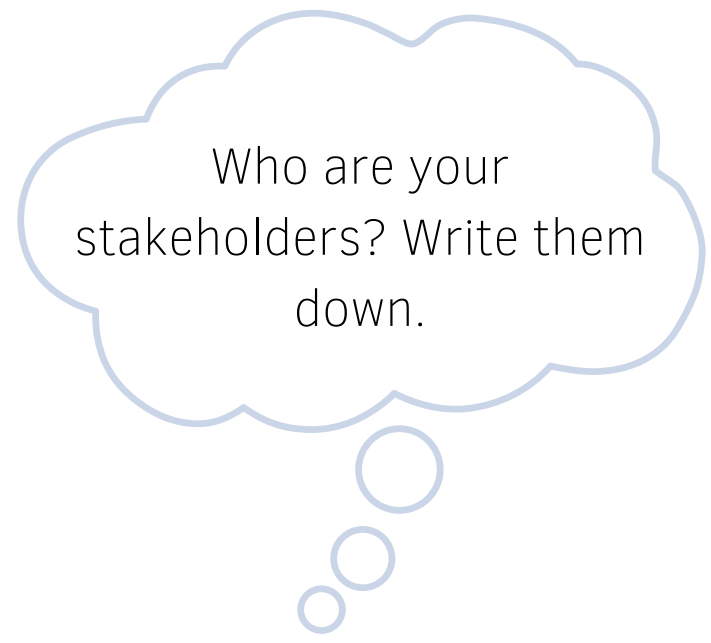

Stakeholders include those who are directly or indirectly impacted.

Identify the purpose and impact of the education intervention.

Stakeholder engagement is a continuous process.

HOW TO EVALUATE

2 Create a logic model

The logic model is intended to be a process that illustrates the **pathway of change** from developing the evidence-based interventions to the outcomes measured in the evaluation.

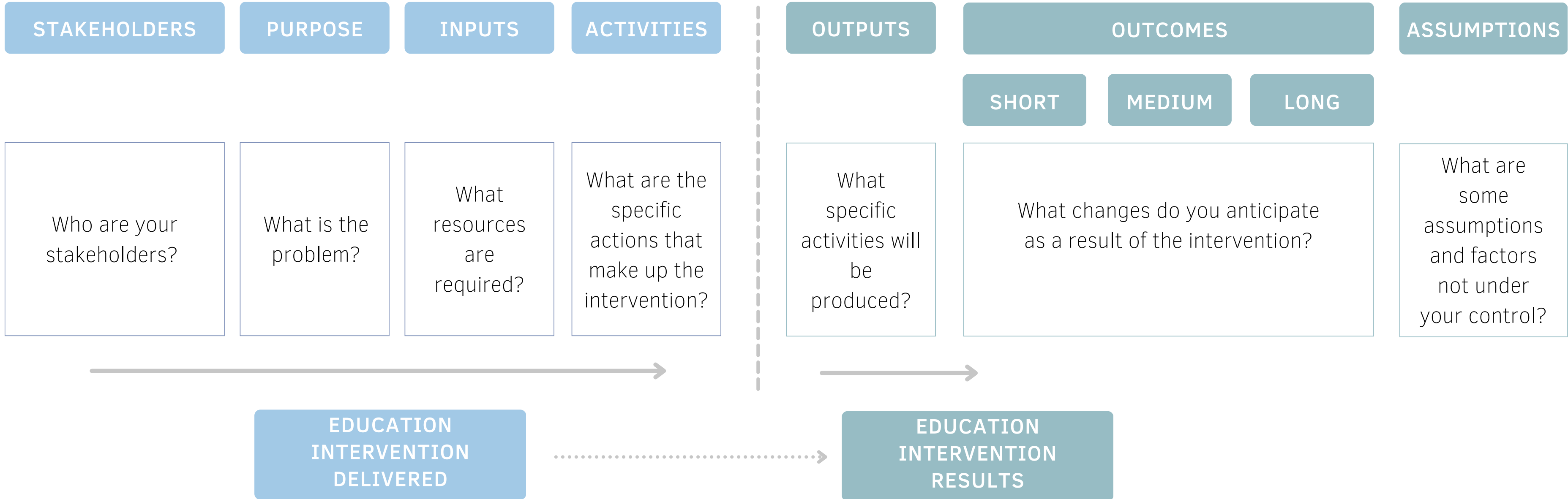

2 Example of a logic model

Goal: To develop a case-based learning session for CE that drives sustained mastery and performance of professional capability.

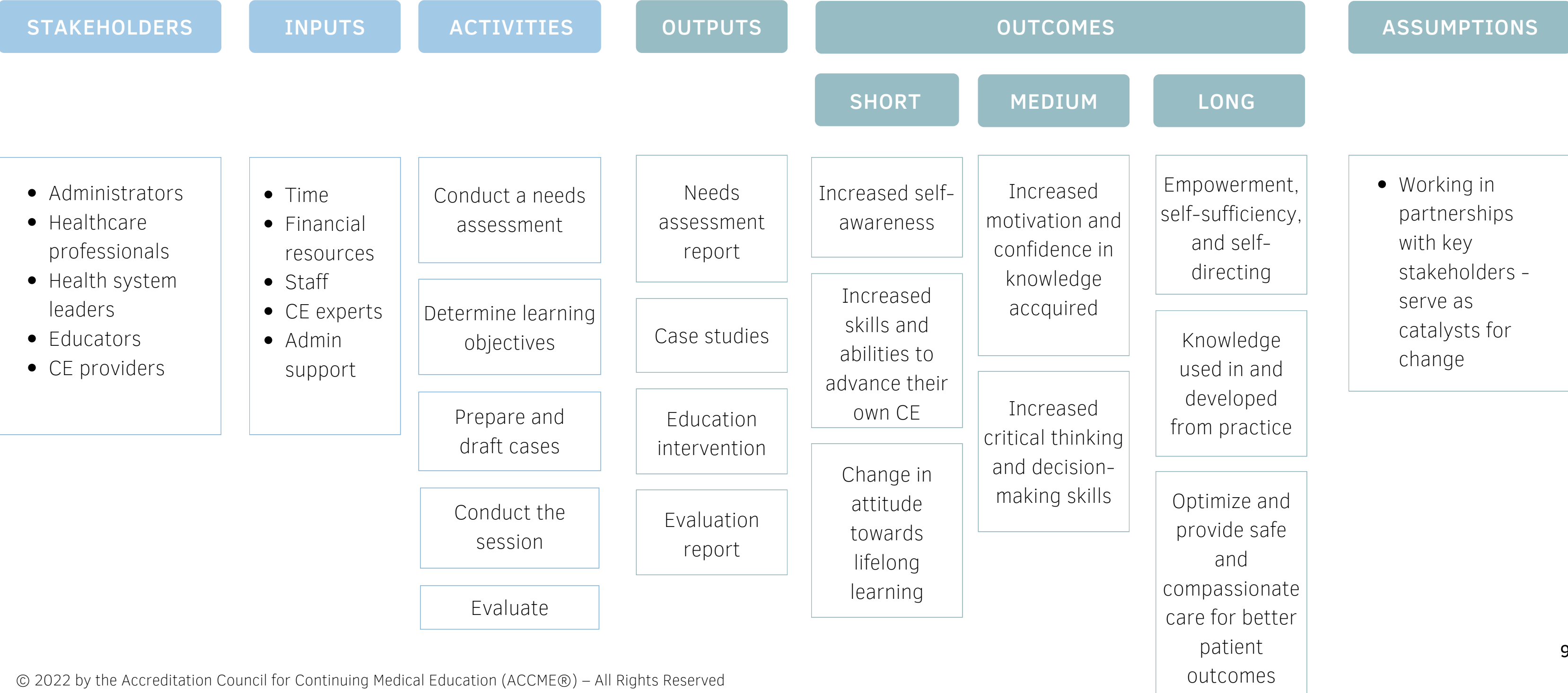

HOW TO EVALUATE

Practice: Create your own logic model



Goal: _____

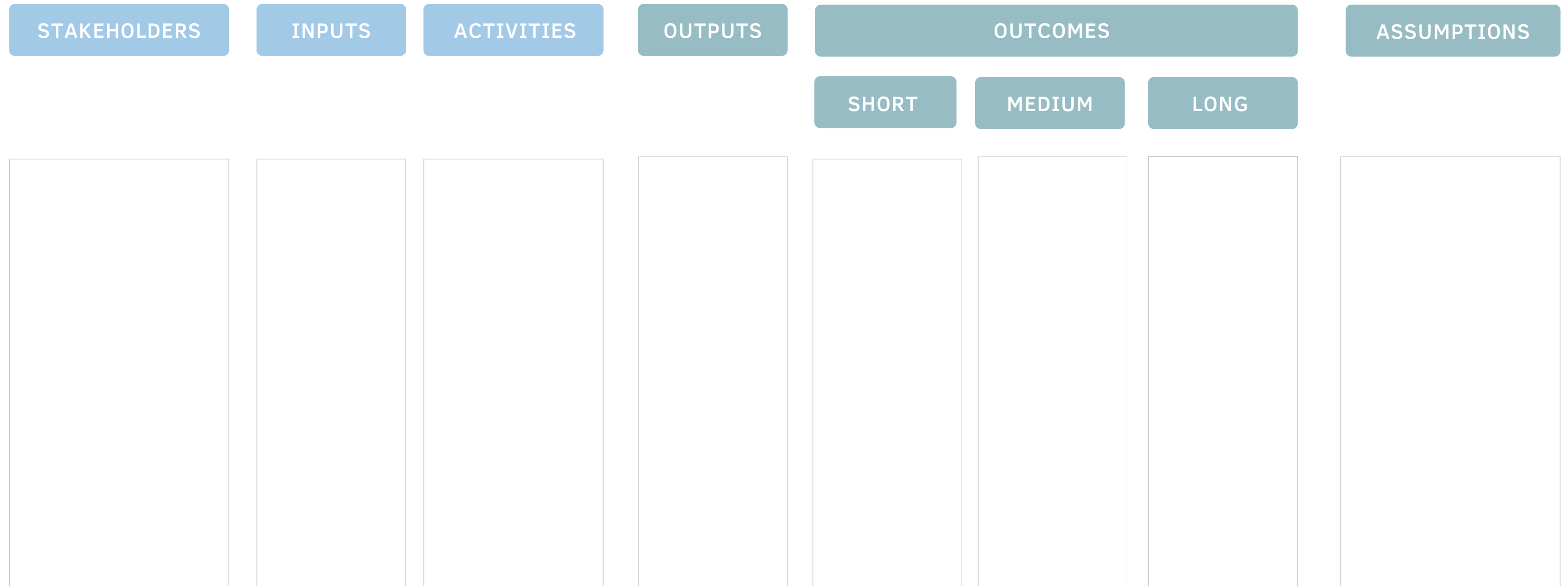

3

Select an outcome framework for evaluation



CE leaders can leverage the following frameworks to develop an education intervention that is learner-centric.

Outcomes are changes in learners' knowledge, skills, and attitudes. The frameworks below can be used to form your evaluation questions (e.g., surveys and/or interview guides). Please see [pages 166-176](#) to guide you through this process. The choice of the evaluation framework is often dependent on the context of the intervention.

RE-AIM Framework	Kirkpatrick-Barr Framework	Moore's Framework
<p>The RE-AIM framework could be utilized as a guiding framework for evaluating the intervention [67-68].</p> <p>Reach Effectiveness Adoption Implementation Maintenance</p>	<p>The Kirkpatrick-Barr framework serves as a useful guide in assessing the learners' educational outcomes [69-70].</p> <p>Level 1: Reaction Level 2: Learning Level 3: Behavior Level 4: Performance</p>	<p>The Moore's framework could also be used to assess the learners' educational outcomes [71].</p> <p>Level 1: Participation Level 2: Satisfaction Level 3: Learning (declarative and procedural knowledge) Level 4: Learning (competence) Level 5: Performance Level 6: Patient Health Level 7: Community Health</p>

Note: Both Kirkpatrick-Barr and Moore's frameworks assess the learners' educational outcomes. You could use either framework.

RE-AIM framework

Use the RE-AIM framework to assess whether the CE education intervention is effective in driving current and sustained mastery and performance of professional capability. Below are some guiding questions to help you evaluate [3]:

HOW TO EVALUATE

Element	Description	Guiding Question	Tools
Reach	Number, proportion, and representativeness of healthcare professionals taking part in the CE intervention [3].	How do I reach the intended population with the educational intervention [3]?	<ul style="list-style-type: none"> • Pre/post quantitative assessments
Effectiveness	Impact of the CE intervention on key outcomes [3].	How do I know my educational intervention is effective [3]?	<ul style="list-style-type: none"> • Semi-structured interviews • Surveys
Adoption	Number, proportion, and representativeness of organizations and leaders/educators willing to initiate a CE intervention [3].	How do I support organizations to deliver this educational intervention successfully [3]?	<ul style="list-style-type: none"> • Feedback or debriefs at the end of the session
Implementation	Delivery of the CE intervention (i.e., consistency of delivery, time, and cost) [3].	How do I ensure the educational intervention is delivered effectively [3]?	<ul style="list-style-type: none"> • Usability metrics • Practice audit • Self-reported data
Maintenance	Long-term impact of the CE intervention on outcomes [3].	How do I sustain the educational intervention in the long term [3]?	<ul style="list-style-type: none"> • Observations

RE-AIM framework

RE-AIM

- Adaptation of Price and colleagues' metrics for CE interventions [3,67-68].
- These outcome measures will help CE leaders or educators evaluate the education intervention at every stage of the **RE-AIM framework** to ensure it is effective and sustainable.

REACH

- Number of target audience participating in the education intervention.
- Number of healthcare professionals receiving credit for participating (based on profession).
- Number of credits awarded for each activity.
- Number of healthcare professionals reached.

EFFECTIVENESS

- Percentage of participants who attained passing levels in learning activities.
- Number of participants attaining target performance.
- Percentage of participants making changes in their clinical practice as a result of the intervention.
- Self-reported change in knowledge and/or confidence levels.

ADOPTION

- Feedback or comments from participants regarding potential facilitators and challenges to making changes in practice.
- Participants' intention and self-efficacy to make change.
- Percentage of healthcare professionals adopting intervention as a strategy to engage in lifelong learning.

IMPLEMENTATION

- Number of activities associated with the implementation strategy.
- Time spent on each activity.
- Number of teams or organizations implementing changes in practice.
- Feedback or comments from participants regarding potential facilitators and challenges to making changes in practice.

MAINTENANCE

- Percentage of participants maintaining target practice change.
- Continuous evaluation of intervention (quality metrics).
- Optimize and provide safe and compassionate care for better patient outcomes.

Kirkpatrick-Barr framework

Use the Kirkpatrick-Barr framework to assess the educational outcomes of the CE intervention. The framework shows 4 levels of educational outcomes that can be assessed.

Level 1:

- Assess the satisfaction with learning ([pre/post surveys](#)).
- Overall quality of education intervention, delivery, and instructors [69-70].

REACTION

Level 2:

- Improved knowledge and skills from learning [69-70].
- Change in attitudes toward lifelong learning ([pre/post surveys](#)) [69-70].
- Increased confidence in decision making.

LEARNING

Level 3:

- Participants' intention and self-efficacy to make a change.
- Understand planned changes and whether they were achieved ([follow-up surveys or interviews, observations](#)) [69-70].

BEHAVIOR

Level 4:

- Changes to organizational practice and improvements in care delivery ([electronic medical record \[EMR\] data](#))[69-70].

PERFORMANCE

Moore's framework

The Moore's framework can also be used to assess the educational outcomes of the CE intervention [71-72].

Level	Description	Question	Data Source
Level 1: Participation	Number of healthcare professionals who participated in the CE session	Who participated in the session?	Demographic information; attendance data
Level 2: Satisfaction	Assess participants' satisfaction with CE session	What did participants think about the session? Would they recommend it?	Post-evaluation surveys
Level 3: Learning (declarative and procedural)	Immediate feedback on the learning - assess participants' knowledge based on the learning objectives	Did participants acquire new knowledge or reinforce existing knowledge?	Pre- and post- evaluation surveys; self-reported data; case-based clinical vignettes
Level 4: Learning (competence)	Assess the application of the learning in practice setting.	Were participants able to demonstrate the knowledge learned in practice?	Pre- and post- evaluation surveys; self-reported data; case-based clinical vignettes
Level 5: Performance	Follow-up evaluation of practice change	Is there a change in behavior as a result of attending this CE session?	Observations; patient charts; administrative data
Level 6: Patient Health	Practice change has an impact on patient health	Did the participant's behavior as a result of the CE session positively affect patient care?	Patient charts, patient self-reported data
Level 7: Community Health	Practice changes improve the health status of the community	Did the participant's behavior as a result of the CE session positively affect community health?	Epidemiological data

Evaluate if learners achieve outcomes



An important part of the evaluation of CE sessions is to assess whether desirable clinical outcomes were achieved. This includes measuring the impact of CE sessions on learners' performance, healthcare quality improvement and/or the health of patients families, and communities. The following are critical elements to measure in order to assess if outcomes were achieved and if the CE session had an impact:

HOW TO EVALUATE

Improve performance

Assess the impact of the CE activity on the performance of healthcare providers (e.g., changes to pre-operative procedures) and measure performance changes among learners [73].

Improve healthcare quality

Assess whether the CE activity leads to improvements in care delivery or system performance and if there is collaboration in the process of quality improvement [73].

Improve patient/ community health

Assess whether the CE activity lead to improvements in health outcomes for patients or their communities and if there is collaboration in the process of improvement [73].



Evaluation approaches

Below are some examples of evaluation approaches to collect data on whether the CE activity impacted behavior change, practice change or skill development. Consider following up at various time points to inquire about change. Evaluation does not need to be limited to one approach for each CE activity.

Feedback survey

- Focused on the participants' satisfaction with the education activity:
 - Content of the session and instructor
 - Length of the session
 - Anticipated changes in practice based on session
 - Barriers and facilitators to change
 - Self-efficacy
 - Conflict or perceived bias

Knowledge tests

- Administered pre- and post- activity.
- Pre- and post- scores reflect a measure of change (difference score)
- Effective in identifying knowledge gaps and increases in knowledge [38]

Analysis of reflective statements

- Assess whether the learning objectives were achieved
- Knowledge comprehension of learners
- Changes in practice based on the CE session

Semi-structured interviews

- Structure questions based on Kirkpatrick-Barr framework [69-70]
- Use a semi-structured interview guide to review participant experiences and suggestions for improving

Additional evidence-based evaluation approaches

Clinical vignettes

- Vignettes help to measure the process of care delivery in practice settings [72].
- Vignettes are structured in sections based on the sequence of a medical visit, followed by open-ended responses to a series of guiding questions [72].

Simulation

- Learners participate in a role-play or simulation to apply and demonstrate their knowledge. Best practices are also shared throughout or at the end of the session. Through this process, gaps in knowledge can be identified and addressed [74],

Written responses

- Learners reflect on their practice behaviour and write an action plan regarding any performance. The facilitator summarizes the discussion and identifies next steps [74].

Learning from teaching

- Knowledge gaps are identified by the facilitator via reflective assessment. Structured feedback on the learning gaps can be provided by a peer or mentor [74].

Practice: CE planning worksheet



Use this worksheet to start planning out the structure, content, and evaluation components of your CE session.

Needs and gaps:

Activity learning objectives:

Learning activities/ teaching modalities:

Theoretical basis:

Outcome methods (how you are going to evaluate):

Time frame (when you will collect data):

Sample: Post-evaluation survey

1. What did you learn or how will this session impact your practice?

2. What competency areas were improved as a result of the CE session (e.g., patient care, clinical knowledge, systems-based practice)?

3. Identify three professional or practice gaps that you would like addressed in a future CE session.

4. What changes will you make in your practice as a result of this session?

5. What did you find most effective about this session?

6. Thank you for providing feedback. We would love to hear more if you have any additional comments to share related to your learning experience.

Sample: Interview guide

This is a sample interview guide based on the [RE-AIM framework](#).

Practice Context

1. Please describe your current professional setting.

Prompt: where you work

Prompt: length of time in current role

Effectiveness

2. Tell us about your overall learning experience and to what extent it met or didn't meet your expectations or needs?

3. Do you feel as though your participation in this session contributed to your professional development?

4. What were the elements in the CE session that helped to make it a meaningful learning experience for you?

Prompt: Lectures, discussions, case studies, etc.

Prompt: Positive or negative experience

Implementation

5. What are your thoughts on the facilitation skills and knowledge of the facilitators?

Reach

6. How equitable was the CE session, meaning to what extent did you feel the session:

Prompt: Accounted for different geographic locations, ability, access to technology, resources, work schedule, and other learner factors?

Prompt: Provided regular check-ins?

Prompt: Provided timely and useful feedback?

Maintenance

7. If you were teaching this session, what would you keep? What would you change?

8. What are your final suggestions or thoughts about your learning experience?

That concludes our interview. Thank you for participating and helping us to improve our CE session. Do you have any questions?

Evaluation checklist



THINGS TO THINK ABOUT WHEN ASSESSING THE EDUCATIONAL INTERVENTION

What would you like to evaluate?

- Facilitator
- Course material
- Knowledge gain or retention
- Achievement of learning goals
- Sustainability of the intervention

When would you like to evaluate?

- Post-evaluation
- Mid-evaluation
- Long-term outcomes

How would you like to evaluate?

- Knowledge tests
- Feedback surveys
- Debriefs
- Semi-structured interviews
- Focus groups

Were **IDEA** principles considered?

- Inclusion
- Diversity
- Equity
- Accessibility
- CAMH Framework [9]

Additional resources

Further reading



- Frye AW, Hemmer PA. Program evaluation models and related theories: AMEE Guide No. 67. Med Teach. 2012;34(5):e288-99. doi: [10.3109/0142159X.2012.668637](https://doi.org/10.3109/0142159X.2012.668637)
- Haji F, Morin M-P, Parker K. Rethinking programme evaluation in health professions education: beyond 'did it work?'. Medical Education. 2013;47(4):342-51. doi: [10.1111/medu.12091](https://doi.org/10.1111/medu.12091)
- Moore DE, Jr., Green JS, Gallis HA. Achieving desired results and improved outcomes: integrating planning and assessment throughout learning activities. J Contin Educ Health Prof. 2009;29(1):1-15. doi: [10.1002/chp.20001](https://doi.org/10.1002/chp.20001)

Reassess CE planning preparedness



If you are planning a CE session, use the following self-assessment tool to identify areas in the toolkit that will be beneficial to you. Focus your time on sections in the toolkit where you report low confidence to refine your skillset in CE planning and design. If you report confidence from levels 1 to 3, you may want to go through the content thoroughly and complete the activities. If you report a confidence level from 4 to 5, use the toolkit as a reference resource and use the worksheets to help with the design of your CE session.

Please rate your **level of confidence** with each of the CE planning components, learning formats, and evaluation activities on a scale of 1 (not at all familiar) to 5 (extremely familiar).

CE Component	Confidence level: 1 (Not at all) - 5 (Extremely)				
Initiating planning of CE session	1	2	3	4	5
Structuring a longitudinal and multimodal education intervention	1	2	3	4	5
Conducting a needs assessment	1	2	3	4	5
Developing learning objectives	1	2	3	4	5
Integrating principles of inclusion, diversity, equity, and accessibility into activities	1	2	3	4	5
Delivering CE sessions virtually	1	2	3	4	5
Facilitating small group learning	1	2	3	4	5
Planning and encouraging small group discussion	1	2	3	4	5
Creating an inclusive, safe, and supportive learning space	1	2	3	4	5
Maintaining group dynamics	1	2	3	4	5
Mitigating challenges and conflicts in groups	1	2	3	4	5

Self-assessment for CE planning preparedness



Please continue to rate your **level of confidence** with each of the CE planning components, learning formats, and evaluation activities on a scale of 1 (not at all familiar) to 5 (extremely familiar).

CE Component	Confidence level: 1 (Not at all) - 5 (Extremely)				
Case-based learning	1	2	3	4	5
Developing a case for activities	1	2	3	4	5
Presenting the use diverse methods and modalities	1	2	3	4	5
Identifying strategies for examining and engaging learners in case analysis	1	2	3	4	5
Defining the facilitator's role in case-based learning discussion	1	2	3	4	5
Conducting activities to disseminate case analysis and debrief the case	1	2	3	4	5
Reflective Learning	1	2	3	4	5
Determining learning goals and when to integrate reflective learning	1	2	3	4	5
Defining facilitator's role in reflective learning	1	2	3	4	5
Applying and integrating the critical reflective inquiry model in activities	1	2	3	4	5
Assessing and Evaluating CE Interventions	1	2	3	4	5
Assessing knowledge comprehension of learners	1	2	3	4	5
Providing and integrating feedback	1	2	3	4	5
Evaluating outcomes of intervention using structured frameworks	1	2	3	4	5
Selecting evaluation approaches to assess performance change or skill development	1	2	3	4	5

Glossary of terms

Note: Some of the definitions below state physicians; however, we recognize the need for all healthcare professionals.

Active learning: An instructional design approach that fosters the application of knowledge, analysis, and synthesis by engaging learners through activities such as case scenarios and problem-solving [35].

Case-based learning: An educational intervention that describes when learners learn by solving real world problems [34].

Competence: In the context of evaluating effectiveness of a CE activity in the ACCME system, the extent to which learners know how to implement (or stop doing) what the activity intended to teach them [1].

Continuing education (CE): The educational activities that serve to maintain, develop, or increase the knowledge, skills, and professional performance and relationships health professionals uses to provide services for patients, the public, or the profession. CE represents that body of knowledge and skills generally recognized and accepted by the profession as within the basic medical sciences, the discipline of clinical medicine, and the provision of healthcare to the public [1].

Glossary of terms

Continuing professional development (CPD): Includes all activities that any health professional undertakes, formally and informally, including CE, in order to maintain, update, develop, and enhance their knowledge, skills, and attitudes in response to the needs of their patients [1].

Critical reflective inquiry (CRI): This model enables care providers to learn from their experiences and evaluate by exploring the knowledge, beliefs, and attitudes ingrained in clinical practice settings [51].

Faculty: The individuals responsible for teaching, authoring, or otherwise communicating the activity content to learners [1].

Group dynamics: The behavior and attitude patterns involved when learners interact with each other [20].

Inquiry-based learning: Enables learners to actively participate and construct knowledge through a self-directed learning process and problem-solving skills [36].

Knowledge: In the context of educational needs for a CE activity in the ACCME system, the extent to which learners have a need for new information [1].

Glossary of terms

Learner: An attendee at an activity. See also physician learners, and other learners [1].

Learning from teaching: Personal learning projects designed and implemented by the learner with facilitation from the accredited provider. It recognizes the learning that occurs as physicians prepare to teach [1].

Live activity: Activity that occurs at a specific time as scheduled by the accredited CE provider. Participation may be in person or remotely as is the case of teleconferences or live internet webinars [1].

Mind map: A creative and logical method of note-taking and note-making that maps out your ideas [21].

Performance: In the context of evaluating effectiveness of a CE activity in the ACCME system, the extent to which learners do what the CE activity intended them to be able to do (or stop doing) in their practice [1].

Glossary of terms

Problem-based learning: Fostering an interactive learning experience that establishes a context focused on clinical practice through presenting and solving real-world cases [37].

Reflective learning: A type of learning where learners critically reflect upon their own thoughts, behaviors, and actions in practice scenarios [51-52].

Small group learning: An instructional approach that encompasses active participation, purposeful activities, and face-to-face interaction. It is a concerted and collaborative effort in learning new knowledge and skills, and attaining a mutual objective [19].

Team-based learning: A learner-centered approach that encourages learners to work collaboratively and learn from each other [75].

References

1. Accreditation Council for Continuing Medical Education (ACCME®) and American Medical Association (AMA) Glossary of Terms and Definitions. 2021.
2. Manley K, Martin A, Jackson C, Wright T. A realist synthesis of effective continuing professional development (CPD): A case study of healthcare practitioners' CPD. *Nurse Educ Today*. 2018;69:134-41.
3. Trevelyan EG, Robinson PN. Delphi methodology in health research: how to do it? *European Journal of Integrative Medicine*. 2015;7(4):423-8.
4. Williams BW, Kessler HA, Williams MV. Relationship among practice change, motivation, and self-efficacy. *J Contin Educ Health Prof*. 2014;34 Suppl 1:S5-10.
5. Bandura A. Self-efficacy: toward a unifying theory of behavioral change. *Psychol Rev*. 1977;84(2):191-215.
6. Martin KOK, Mazmanian PE. Anticipated and encountered barriers to change in CME: Tools for planning and evaluation. *J Contin Educ Health Prof*. 1991;11(4):301-18.
7. Price DW, Miller EK, Rahm AK, Brace NE, Larson RS. Assessment of barriers to changing practice as CME outcomes. *J Contin Educ Health Prof*. 2010;30(4):237-45.
8. Shirazi M. Designing Effective CME—Potential barriers to practice change in the management of depression: A qualitative study. *Psychology*. 2013;(4):25-31.
9. Price DW, Davis DA, Filerman GL. Systems-integrated CME: The implementation and outcomes imperative for continuing medical education in the learning health care enterprise. *NAM Perspectives*. Discussion, National Academy of Medicine, Washington, DC, 2021.
10. Regnier K, Kopelow M, Lane D, Alden E. Accreditation for learning and change: Quality and improvement as the outcome. *J Contin Educ Health Prof*. 2005;25(3).

References

11. Cleghorn GD, Headrick LA. The PDSA cycle at the core of learning in health professions education. *Jt Comm J Qual Improv.* 1996;22(3):206-12.
12. Norman GR, Shannon SI, Marrin ML. The need for needs assessment in continuing medical education. *BMJ.* 2004;328(7446):999.
13. Pilcher J. Learning needs assessment: Not only for continuing education. *J Nurses Prof Dev.* 2016;32(4):122-9.
14. Aherne M, Lambie W, Davis P. Continuing medical education, needs assessment, and program development: Theoretical constructs. *J Contin Educ Health Prof.* 2001;21(1):6-14.
15. Painter AF. Needs assessment guidelines: Wright State University; 2016. Available from: <https://medicine.wright.edu/continuing-medical-education/needs-assessment-guidelines>.
16. Légaré F, Freitas A, Thompson-Leduc P, Borduas F, Luconi F, Boucher A, et al. The majority of accredited continuing professional development activities do not target clinical behavior change. *Acad Med.* 2015;90(2):197-202.
17. Adams NE. Bloom's taxonomy of cognitive learning objectives. *J Med Libr Assoc.* 2015;103(3):152-3.
- 17a. Anderson, L. W., & Krathwohl, D. R. (2001). *A Taxonomy for Learning, Teaching and Assessing: A Revision of Bloom's Taxonomy of Educational Objectives: Complete Edition.* New York: Longman.
- 17b. Ref: Stanny, Claudia J. 2016. "Reevaluating Bloom's Taxonomy: What Measurable Verbs Can and Cannot Say about Student Learning" *Education Sciences* 6, no. 4: 37. <https://doi.org/10.3390/educsci6040037>
18. Agic B, et al. Health equity and inclusion framework for education and training. Centre for Addiction and Mental Health: Canada. 2021.
19. Wong FMF. A phenomenological research study: Perspectives of student learning through small group work between undergraduate nursing students and educators. *Nurse Educ Today.* 2018;68:153-8.

References

20. Burgess A, van Diggele C, Roberts C, Mellis C. Facilitating small group learning in the health professions. *BMC Medical Education*. 2020;20(2):457.
21. Edwards S, Cooper N. Mind mapping as a teaching resource. *Clin Teach*. 2010;7(4):236-9.
22. Park C, Wu C, Regehr G. Shining a light Into the black box of group learning: Medical students' experiences and perceptions of small groups. *Acad Med*. 2020;95(6):919-24.
23. Meo SA. Basic steps in establishing effective small group teaching sessions in medical schools. *Pak J Med Sci*. 2013;29(4):1071-6.
24. Lemoine ER, Rana J, Burgin S. Teaching and learning tips 7: Small-group discussion. *Int J Dermatol*. 2018;57(5):583-6.
25. Edmunds S, Brown G. Effective small group learning: AMEE Guide No. 48. *Med Teach*. 2010;32(9):715-26.
26. Kitchen M. Facilitating small groups: how to encourage student learning. *Clin Teach*. 2012;9(1):3-8.
27. van Diggele C, Burgess A, Mellis C. Planning, preparing and structuring a small group teaching session. *BMC Medical Education*. 2020;20(2):462.
28. Davies R, Yeung E, Mori B, Nixon SA. Virtually present: The perceived impact of remote facilitation on small group learning. *Med Teach*. 2012;34(10):e676-83.
29. Armson H, Kinzie S, Hawes D, Roder S, Wakefield J, Elmslie T. Translating learning into practice: lessons from the practice-based small group learning program. *Can Fam Physician*. 2007;53(9):1477-85.
30. Golaghaie F, Asgari S, Khosravi S, Ebrahimimonfared M, Mohtarami A, Rafiei F. Integrating case based learning with collective reflection: outcomes of inter-professional continuing education. *Reflective Practice*. 2019;20(1):42-55.

References

31. Bay BH, Tay SSW, Srinivasan DK. Facilitating small group learning. *Teaching anatomy: A practical guide*. Cham: Springer International Publishing; 2020:133-41.
32. Tuckman BW. Developmental sequence in small groups. *Psychol Bull*. 1965;63:384-99.
33. Tuckman BW, Jensen MAC. Stages of small-group development revisited. *Group & Organization Studies*. 1977;2(4):419-27.
34. Shaw T, Janssen A, Barnett S, Nicholson J, Avery J, Heneka N, et al. The CASE methodology: A guide to developing clinically authentic case-based scenarios for online learning programs targeting evidence-based practice. 2018;1.
35. Niemi H. Active learning—a cultural change needed in teacher education and schools. *Teaching and Teacher Education*. 2002;18(7):763-80.
36. Pedaste M, Mäeots M, Siiman LA, de Jong T, van Riesen SAN, Kamp ET, et al. Phases of inquiry-based learning: Definitions and the inquiry cycle. *Educational Research Review*. 2015;14:47-61.
37. Sargeant JM, Purdy RA, Allen MJ, Nadkarni S, Watton L, O'Brien P. Evaluation of a CME problem-based learning internet discussion. *Acad Med*. 2000;75(10 Suppl):S50-2.
38. Thistlethwaite JE, Davies D, Ekeocha S, Kidd JM, MacDougall C, Matthews P, et al. The effectiveness of case-based learning in health professional education. A BEME systematic review: BEME Guide No. 23. *Med Teach*. 2012;34(6):e421-44.
39. Kim S, Phillips WR, Pinsky L, Brock D, Phillips K, Keary J. A conceptual framework for developing teaching cases: a review and synthesis of the literature across disciplines. *Med Educ*. 2006;40(9):867-76.

References

40. McLean SF. Case-based learning and its application in medical and health-care fields: A review of worldwide literature. *J Med Educ Curric Dev*. 2016;3.
41. Case method teaching and learning. United States: Columbia University in the City of New York; Available from: <https://ctl.columbia.edu/resources-and-technology/resources/case-method/>.
42. Pilcher J. Promoting learning using case-based strategies in nursing professional development. *Journal for Nurses in Professional Development*. 2018;34(4):199-205.
43. Yoo MS, Park JH. Effect of case-based learning on the development of graduate nurses' problem-solving ability. *Nurse Educ Today*. 2014;34(1):47-51.
44. Furlan AD, Zhao J, Voth J, Hassan S, Dubin R, Stinson JN, et al. Evaluation of an innovative tele-education intervention in chronic pain management for primary care clinicians practicing in underserved areas. *J Telemed Telecare*. 2019;25(8):484-92.
45. Kühne-Eversmann L, Eversmann T, Fischer MR. Team- and case-based learning to activate participants and enhance knowledge: an evaluation of seminars in Germany. *J Contin Educ Health Prof*. 2008;28(3):165-71.
46. Tadayon Nabavi R. Bandura's social learning theory and social cognitive learning theory. 2012.
47. Medical education in the information age: Engaging learners and creating change across the continuum, Graham McMahan, MD, MMSc, Plenary Address, Association for Hospital Medical Education Annual Spring Institute, May 13, 2021.

References

48. Wallace ML, Walker JD, Braseby AM, Sweet MS. Now, what happens during class? Using team-based learning to optimize the role of expertise within the flipped classroom. *Journal on Excellence in College Teaching*. 2014;25(3):253-73.
49. Goldberg LR, Brown GR, Mosack VA, Fletcher PA. Student reflections following exposure to a case-based interprofessional learning experience: Preliminary findings. *J Interprof Care*. 2015;29(4):380-2.
50. Kovacevic P, Dragic S, Kovacevic T, Momcicevic D, Festic E, Kashyap R, et al. Impact of weekly case-based tele-education on quality of care in a limited resource medical intensive care unit. *Crit Care*. 2019;23(1):220.
51. Asselin ME, Fain JA. Effect of reflective practice education on self-reflection, insight, and reflective thinking among experienced nurses: a pilot study. *J Nurses Prof Dev*. 2013;29(3):111-9.
52. Cole M. Learning through reflective practice: a professional approach to effective continuing professional development among healthcare professionals. *Research in Post-Compulsory Education*. 2000;5(1):23-38.
53. Arao B, Clemens K. From safe spaces to brave spaces. *The art of effective facilitation: Reflections from social justice educators*. 2013:135-150.
54. Ali D, editor. *Safe spaces and brave spaces: Historical context and recommendations for student affairs professionals*. NASPA Policy and Practice Series. 2017; 2.
55. Bolg JR, Dwyer PA, Doherty DP, Pignataro SJ, Renaud AM. The impact of critical reflective inquiry education on experienced nurses' insights into practice. *J Nurses Prof Dev*. 2020;36(2):68-73.

References

56. Mantzourani E, Desselle S, Le J, Lonie JM, Lucas C. The role of reflective practice in healthcare professions: Next steps for pharmacy education and practice. *Research in Social and Administrative Pharmacy*. 2019;15(12):1476-9.
57. Aronson L. Twelve tips for teaching reflection at all levels of medical education. *Med Teach*. 2011;33(3):200-5.
58. Kumagai AK, Naidu T. Reflection, dialogue, and the possibilities of space. *Acad Med*. 2015;90(3):283-8.
59. Sandars J. The use of reflection in medical education: AMEE Guide No. 44. *Med Teach*. 2009;31(8):685-95.
60. Swan K, Garrison D, Richardson J. A constructivist approach to online learning: The community of inquiry framework. *Information technology and constructivism in higher education: Progressive learning frameworks*, 2009:43-57.
61. Morton J. What is a brave space? United States: NC State University; 2020. Available from: <https://diversity.ncsu.edu/news/2020/04/02/what-is-a-brave-space/>.
62. Fragkos KC. Reflective practice in healthcare education: An umbrella review. *Education Sciences*. 2016;6(3):27.
63. Leung KH, Pluye P, Grad R, Weston C. A reflective learning framework to evaluate CME effects on practice reflection. *J Contin Educ Health Prof*. 2010;30(2):78-88.
64. Mann K, Gordon J, MacLeod A. Reflection and reflective practice in health professions education: a systematic review. *Adv Health Sci Educ Theory Pract*. 2009;14(4):595-621.
65. Thiebaud, CM, et al. Methodologies in medical education. Virtual expert panel in Honduras during the COVID-19 pandemic. *Innovare Revista De Ciencia Y Tecnologia* 2021;10(2).
66. Bullock A, Barnes E, Ryan B, Sheen N. Case-based discussion supporting learning and practice in optometry. *Ophthalmic Physiol Opt*. 2014;34(5):614-21.

References

67. Glasgow RE, Vogt TM, Boles SM. Evaluating the public health impact of health promotion interventions: the RE-AIM framework. *Am J Public Health*. 1999;89(9):1322-7.
68. Checklist for inclusion of RE-AIM issues by RE-AIM dimension. United States: RE-AIM; Available from: <https://re-aim.org/learn/checklist-for-inclusion-of-re-aim-issues-by-re-aim-dimension/>.
69. Davis N, Davis D, Bloch R. Continuing medical education: AMEE Education Guide No 35. *Med Teach*. 2008;30(7):652-66.
70. Ramani S, McMahon GT, Armstrong EG. Continuing professional development to foster behaviour change: From principles to practice in health professions education. *Med Teach*. 2019;41(9):1045-52.
71. Moore DE, Jr., Green JS, Gallis HA. Achieving desired results and improved outcomes: integrating planning and assessment throughout learning activities. *J Contin Educ Health Prof*. 2009;29(1):1-15.
72. Peabody JW, Luck J, Glassman P, Dresselhaus TR, Lee M. Comparison of vignettes, standardized patients, and chart abstraction: A prospective validation study of 3 methods for measuring quality. *JAMA*. 2000;283(13):1715-22.
73. Achieves outcomes. United States: Accreditation Council for Continuing Medical Education; Available from: <https://www.accme.org/tutorials/achieves-outcomes>.
74. CME for MOC Evaluation Guide. United States: Accreditation Council for Continuing Medical Education; Available from: <https://www.accme.org/publications/cme-for-moc-evaluation-guide>
75. Koles PG, Stolfi A, Borges NJ, Nelson S, Parmelee DX. The impact of team-based learning on medical students' academic performance. *Acad Med*. 2010 Nov;85(11):1739-45.

CE Educator's Toolkit

Evidence-based design and implementation strategies for effective continuing education

Download the toolkit at www.accme.org/ceeducatorstoolkit

*© 2022 by the Accreditation Council for Continuing Medical Education (ACCME®)
All Rights Reserved.*